

Diode Action or Switching

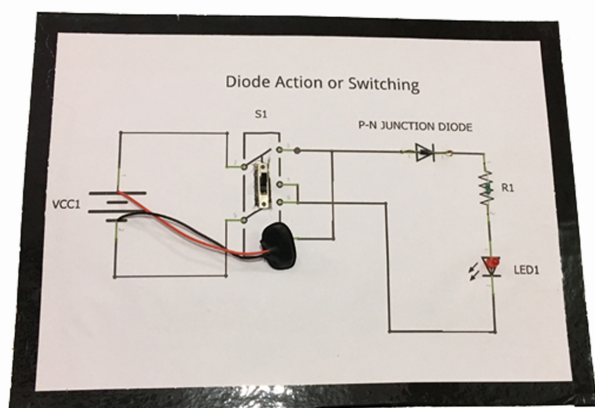

Package Includes:

Branding Free Activity kit

- No Brand Name/Logo/Watermark on Components, PCB & Projects
- Tested Activity kits

Documentation

- Free Project Synopsis – **Embedded below**
- Printed instruction booklet

Support

- Working Video – **Embedded Below**
- Technical Support – WhatsApp@9109087333
- Get Discount Coupon – WhatsApp@9303254433

[Read More](#)

SKU: PH_SPE_39

Price: ~~₹524.00~~ Original price was: ₹524.00. ₹309.00

Current price is: ₹309.00.

Stock: instock

Categories: [Electronics](#), [Physics](#), [Projects](#), [School Project & Experiment](#)

Tags: [class 12th science project and experiment](#), [new science project](#)

Product Description

Download Free Project Synopsis

Disclaimer

This is a handmade complete working Models, Projects & Activity kits supported by rough study material to make a suitable projects report by the student. It is using Cardboard/Wooden base, Paper, Foam based board, stationary items, Electronic-Electrical Components, Mechanical & Scientific goods as per the requirement of a particular model. Colour of product and decoration item may be varying according to availability of material but we make ensure that we will deliver the product with same working, structure and dimensions as describe in product description section.

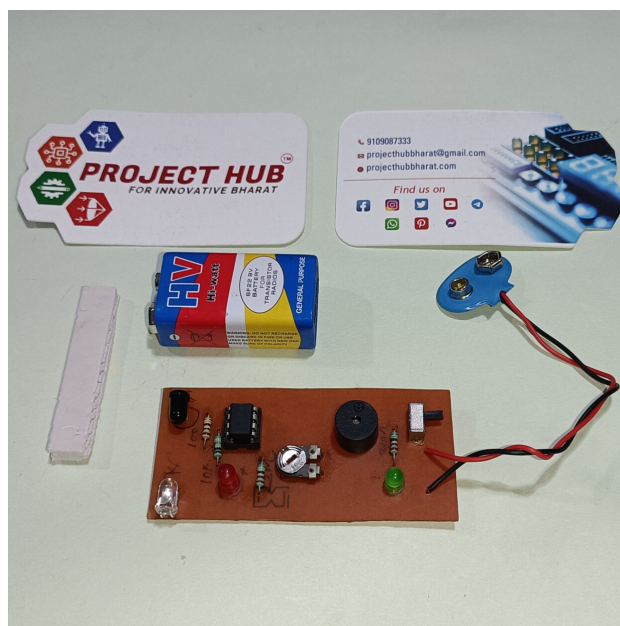

Door Opening Sensor

Available offer

- **Free Shipping** above Rs999.
- Pay with UPI QR [Coupons](#)
- **Special Bulk D** Companies and
- Get Special Dis 9109087333.

Highlights

Branding Free Pr

- No Brand Name/ Projects
- 100% Working p
- Tested Project &

Documentation

- Free Project Syn

- Printed Short Report
- Printable Soft copy of Project Report

Support

- Demo Video – **Embedded below**
- Technical Support – WhatsApp@9109087333
- [Get Discount Coupon](#)

Delivery Time

- **Handling Period** : 1-2 Days
- **Transit Time** :3-5 Days (Approx.)
- **Delivery Time** : Handling Period + Transit Time (4-7 Days Approx.)

[Read More](#)

SKU: PH_EP_007

Price: ~~₹420.00~~ Original price was: ₹420.00. ₹248.00
Current price is: ₹248.00.

Stock: instock

Categories: [Engineering project](#), [IC & Transistor](#), [Mini Project](#), [Projects](#)

Product Description

Download Free Project Synopsis

Working Video

This is a handmade complete working Models, Projects & Activity kits supported by rough study material to make a suitable projects report by the student. It is using Cardboard/Wooden base, Paper, Foam based board, stationary items, Electronic-Electrical Components, Mechanical & Scientific goods as per the requirement of a particular model. Colour of product and decoration item may be varying according to availability of material but we make ensure that we will deliver the product with same working, structure and dimensions as describe in product description section.



Door Opening Transistor &

Available offer

- **Free Shipping** above Rs999.
- Pay with UPI QR [Coupons](#)
- **Special Bulk D** Companies and
- Get Special Dis 9109087333.

Highlights

Branding Free Pr

- No Brand Name/ Projects
- 100% Working p
- Tested Project &

Documentation

- Free Project Syn
- Printed Short Re
- Printable Soft co

Support

- Demo Video – **En**
- Technical Suppo
- [Get Discount Co](#)

Delivery Time

- **Handling Perio**

- **Transit Time** :3-5 Days (Approx.)
- **Delivery Time** : Handling Period + Transit Time (4-7 Days Approx.)

[Read More](#)

SKU: PH_EP_125

Price: ~~₹332.00~~ Original price was: ₹332.00. ₹196.00
Current price is: ₹196.00.

Stock: instock

Categories: [Engineering project](#), [IC & Transistor](#), [Mini Project](#), [Projects](#)

Product Description

[Download Free Project Synopsis](#)

[Working Video:](#)

Disclaimer:

This is a handmade complete working Models, Projects & Activity kits supported by rough study material to make a suitable projects report by the student. It is using Cardboard/Wooden base, Paper, Foam based board, stationary items, Electronic-Electrical Components, Mechanical & Scientific goods as per the requirement of a particular model. Colour of product and decoration item may be varying according to availability of material but we make ensure that we will deliver the product with same working, structure and dimensions as describe in product description section.



Edge Avoidance Arduino & I

Available offer

- **Free Shipping**
orders above ₹
- Pay with UPI QR
Discount./ [Cou](#)
- **Special Bulk**
Companies an
- Get Special Dis
WhatsApp@91

Highlights

Branding Free Pr

- No Brand Nam
PCB & Projects
- 100% Working
- Tested Project

Documentation

- Free Project Sy
- Printed Short P
- Printable Soft

Support

- Demo Video –
- Technical Supp
- [Get Discount C](#)

Delivery Time

- **Handling Period** : 1-2 Days
- **Transit Time** :3-5 Days (Approx.)
- **Delivery Time** : Handling Period + Transit Time (4-7 Days Approx.)

Click Here to Buy Do It Yourself Kit

[Read More](#)

SKU: PH_EP_106

Price:

Stock: instock

Categories: [Arduino](#), [Engineering project](#), [Mechanical Projects](#), [Robotics](#)

Product Description

Download Free Project Synopsis

Working Video

Disclaimer:

This is a handmade complete working Models, Projects & Activity kits supported by rough study material to make a suitable projects report by the student. It is using Cardboard/Wooden base, Paper, Foam based board, stationary items, Electronic-Electrical Components, Mechanical & Scientific goods as per the requirement of a particular model. Colour of product and decoration item may be varying according to availability of material but we make ensure that we will deliver the product with same working, structure and dimensions as describe in product description section.



Electric Fuse

Kit Includes:

- **Project Kit**
- **9V Battery**
- **Print Short R**

Available offers:

- **Free Shipping**
orders above ₹
- **Pay with UPI**
Discount./[Coup](#)
- **Special Bulk**
Companies an
- **Get Special D**
WhatsApp@91

Highlights Brand

- No Brand Nam
- PCB & Projects
- 100% Working
- Tested Project

Documentation

- Printed Short F
- Printable Soft

Support

- Demo Video –
- Technical Supp
- [Get Discount C](#)

[Read More](#)

SKU: PH_SPE_41

Price: ₹552.00 Orig
Current price is: ₹3

Stock: instock

Categories: [Electronics](#), [General science](#), [Physics](#), [Projects](#), [School Project & Experiment](#)

Product Description

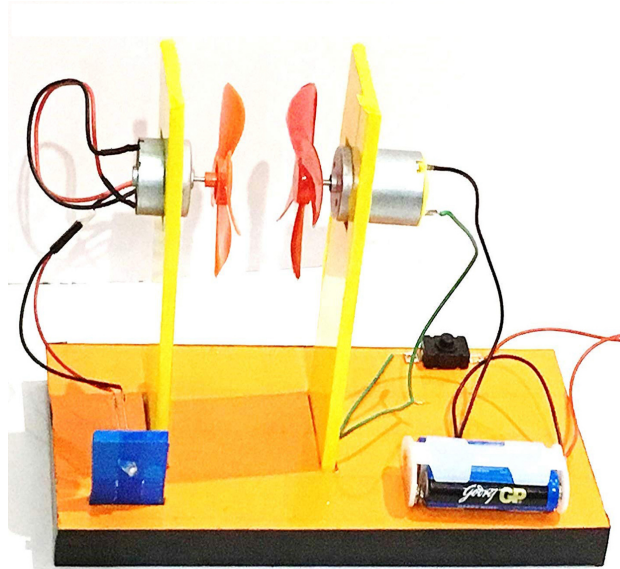

Electric Generator Turbine | Work generation

Package Includes

Branding Free

- No Brand Name
- PCB & Projects
- 100% Working
- Tested Project

Documentation

- Free Project Sy
- Printed instruc

Support

- Working Video
- Technical Supp
- Get Discount C

[Read More](#)

SKU: PH_SPK_012

Price: ₹600.00 Orig
Current price is: ₹5

Stock: instock

Categories: [Hobby](#)

Tags: [electric power generator model](#), [free energy project](#), [science project at home](#)

Product Description

Download Free Project Synopsis

Working Video

This is a handmade complete working Models, Projects & Activity kits supported by rough study material to make a suitable projects report by the student. It is using Cardboard/Wooden base, Paper, Foam based board, stationary items, Electronic-Electrical Components, Mechanical & Scientific goods as per the requirement of a particular model. Colour of product and decoration item may be varying according to availability of material but we make ensure that we will deliver the product with same working, structure and dimensions as describe in product description section.



Electricity a

(□□□□ □□ □□)

Class 6th Sc

KEY BENEFITS:

- **These kits of subject as well as the most eas**
- **These kits are NCERT curric all material f**
- **These kits are for the pract technology a**
- **Don't just re science.**

Package Includes:

Branding Free Activity kit

- No Brand Name/Logo/Watermark on Components, PCB & Projects
- Tested Activity kits

Documentation

- Free Project Synopsis – Embedded below
- Printed instruction booklet

Support

- Working Video – Embedded Below
- Technical Support – WhatsApp@9109087333
- Get Discount Coupon – WhatsApp@9303254433

[Read More](#)

SKU: PH_NCERT_002

Price: ~~₹240.00~~ Original price was: ₹240.00. ₹199.00

Current price is: ₹199.00.

Stock: instock

Categories: [Class 6th](#), [Hobby DIY kits](#), [NCERT based activity kit](#)

Tags: [class 6 project](#), [science exhibition model](#)

Product Description

NCERT based activity kits are designed with an aim to make learning easy and more effective for all the students. These kits are meant to clear all your doubts and concepts which ultimately help you gain a thorough understanding of each and every topic in a subject thereby help to score high in exams as well as it will improve your practical approach toward science and technology. Due to the above benefits of NCERT Activity kits, we will strongly recommend to all students stop rote learning and just start practical side of science.

Disclaimer :

This is a handmade complete working Models, Projects & Activity kits supported by rough study material to make a suitable projects report by the student. It is using Cardboard/Wooden base,

Paper, Foam based board, stationary items, Electronic-Electrical Components, Mechanical & Scientific goods as per the requirement of a particular model. Colour of product and decoration item may be varying according to availability of material but we make ensure that we will deliver the product with same working, structure and dimensions as describe in product description section.

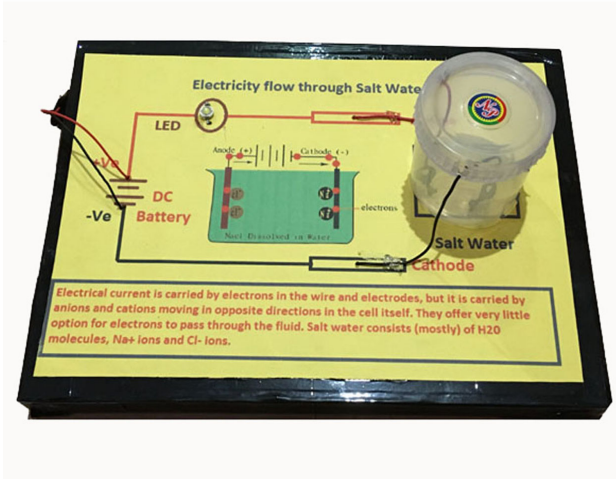

Electricity flow through salt water

Package Includes:

Branding Free Activity kit

- No Brand Name/Logo/Watermark on Components, PCB & Projects
- Tested Activity kits

Documentation

- Free Project Synopsis – **Embedded below**
- Printed instruction booklet

Support

- Working Video – **Embedded Below**
- Technical Support – WhatsApp@9109087333
- Get Discount Coupon – WhatsApp@9303254433

[Read More](#)

SKU: PH_SPE_45

Price: ~~₹544.00~~ Original price was: ₹544.00. ₹321.00
Current price is: ₹321.00.

Stock: instock

Categories: [Chemistry](#), [Physics](#), [Projects](#), [School Project & Experiment](#)

Tags: [class 12th science project and experiment](#), [new science project](#)

Product Description

Download Free Project Synopsis

Disclaimer

This is a handmade complete working Models, Projects & Activity kits supported by rough study material to make a suitable projects report by the student. It is using Cardboard/Wooden base, Paper, Foam based board, stationary items, Electronic-Electrical Components, Mechanical & Scientific goods as per the requirement of a particular model. Colour of product and decoration item may be varying according to availability of material but we make ensure that we will deliver the product with same working, structure and dimensions as describe in product description section.



Electricity V.2.0 Kit

KEY BENEFITS:

- ***These kits of subject as well as the most easy to use.***
- ***These kits are based on NCERT curriculum and include all material for the project.***
- ***These kits are designed for the practical application of technology and science.***
- ***Don't just read about science.***

Package Includes

Branding Free Access

- No Brand Name/Logo/Watermark on Components, PCB & Projects
- Tested Activity kits

Documentation

- Free Project Synopsis – Embedded below
- Printed instruction booklet

Support

- Working Video – Embedded Below
- Technical Support – WhatsApp@9109087333
- Get Discount Coupon – WhatsApp@9303254433

[Read More](#)

SKU: PH_MPK_02

Price: ~~₹2,800.00~~ Original price was: ₹2,800.00. ₹1,999.00 Current price is: ₹1,999.00.

Stock: instock

Categories: [Class 10th](#), [Class 11th](#), [Class 12th](#), [Class 9th](#), [Electricity](#), [Hobby DIY kits](#), [Magnetism](#), [Multi Project Kit](#), [NCERT based activity kit](#)

Tags: [class 6 project](#), [creative science activity for kids](#), [science exhibition model](#)

Product Description

Introducing the **Electricity V2.0 Activity Kit** by Project Hub – Empowering Innovative Bharat, where learning becomes an electrifying journey!

Electricity V2.0

100+ Possible Experiments by using this Kit

best suited for Class 9th to 12th Students



📦 **Unlock the Power of Science:** Ignite your curiosity and dive into the fascinating world of electricity with our cutting-edge activity kit. Designed to align seamlessly with the NCERT curriculum, this kit is tailored for students from 6th to 12th grade, making learning an electrifying adventure for all. 📦 **Hands-On Exploration:** The Electricity V2.0 Activity Kit isn't just a learning tool – it's a hands-on experience that sparks inspiration. With 37 reusable blocks at your fingertips, you can unravel over 100 captivating activities that enhance your understanding of fundamental scientific principles. ✂️ **Unleash Creativity:** Watch as concepts come to life through interactive experiments and projects. From building circuits that light up like constellations to crafting functional gadgets, every activity is an opportunity to explore, innovate, and unleash your creativity. 📦 **Engage, Learn, Excel:** Our activity kit doesn't just teach you about electricity; it helps you grasp the core concepts by putting them into action. Engaging in practical experiments deepens your understanding and cultivates critical thinking skills that are vital for academic success and beyond. 📦 **Complements NCERT Curriculum:** We understand the importance of aligning with your classroom learning. Each activity in the kit is carefully designed to complement the NCERT curriculum, ensuring that your hands-on exploration seamlessly integrates with your academic journey. 📦 **Features:**

- 37 reusable blocks for building circuits and devices.
- Step-by-step guides for over 100 activities.
- Comprehensive materials that cater to varying learning levels.
- A synergy of education and fun, promoting holistic learning.

- Encourages teamwork, problem-solving, and independent thinking.
- Fosters a deep appreciation for science and its practical applications.

📦 **Why Choose Electricity V2.0 Activity Kit?** With Project Hub's unwavering commitment to quality and innovation, the Electricity V2.0 Activity Kit stands as a beacon of progressive education. It's not just a kit – it's a catalyst for sparking curiosity, nurturing ingenuity, and shaping the innovative minds of tomorrow's Bharat. 📦 **Join the Movement:** Embark on a journey where learning knows no bounds. Grab your Electricity V2.0 Activity Kit today and be a part of Project Hub's mission to fuel an innovative Bharat!

Disclaimer :

This is a handmade complete working Models, Projects & Activity kits supported by rough study material to make a suitable projects report by the student. It is using Cardboard/Wooden base, Paper, Foam based board, stationary items, Electronic-Electrical Components, Mechanical & Scientific goods as per the requirement of a particular model. Colour of product and decoration item may be varying according to availability of material but we make ensure that we will deliver the product with same working, structure and dimensions as describe in product description section.



Electrolysis

Kit Includes:

- **Project Kit**
- **9V Battery**
- **Print Short R**

Available offers:

- **Free Shipping** on orders above ₹
- **Pay with UPI** for 5% Discount./[Cou](#)
- **Special Bulk** prices for Companies an
- **Get Special D**iscount on WhatsApp@91

Highlights Branding Free Project / Activity kit

- No Brand Name/Logo/Watermark on Components, PCB & Projects
- 100% Working project
- Tested Project & Activity kits

Documentation

- Printed Short Report
- Printable Soft copy of Project Report

Support

- Demo Video – **Embedded below**
- Technical Support – WhatsApp@9109087333
- [Get Discount Coupon](#)

[Read More](#)

SKU: PH_SPE_42

Price:

Stock: instock

Categories: [Electronics](#), [General science](#), [Physics](#), [Projects](#), [School Project & Experiment](#)

Product Description

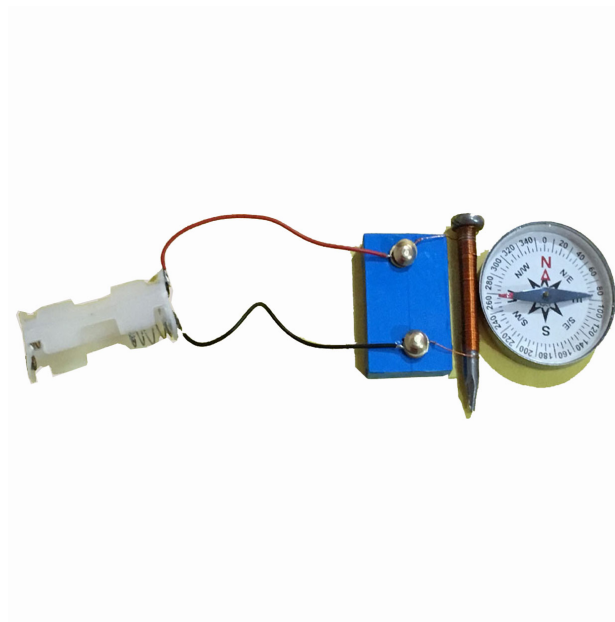

Electromag
Position of
Electromag
Electromag
(Using Com
Package Inc

Branding Free Project / Activity kit

- No Brand Name/Logo/Watermark on Components, PCB & Projects
- 100% Working project
- Tested Project & Activity kits

Documentation

- Free Project Synopsis – ***Embedded below***
- Printed instruction booklet

Support

- Working Video – ***Embedded Below***
- Technical Support – WhatsApp@9109087333
- Get Discount Coupon - WhatsApp@9303254433

[Read More](#)

SKU: PH_SPK_026

Price: ~~₹330.00~~ Original price was: ₹330.00. ₹299.00
Current price is: ₹299.00.

Stock: instock

Categories: [Hobby DIY kits](#), [Science Project kit \(SPK\)](#)

Product Description

Download Free Project Synopsis

Working Video

This is a handmade complete working Models, Projects & Activity kits supported by rough study material to make a suitable projects report by the student. It is using Cardboard/Wooden base, Paper, Foam based board, stationary items, Electronic-Electrical Components, Mechanical & Scientific goods as per the requirement of a particular model. Colour of product and decoration item may be varying according to availability of material but we make ensure that we will deliver the product with same working, structure and dimensions as describe in product description section.

Electromagnet Nails

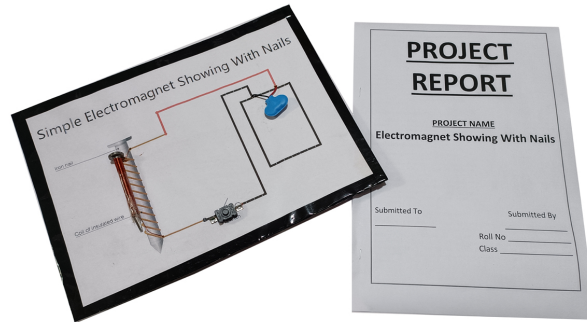

Kit Includes:

- **Project Kit**
- **9V Battery**
- **Print Short R**

Available offers:

- **Free Shipping** on orders above ₹1000
- **Pay with UPI** for 10% Discount./[Coupon](#)
- **Special Bulk** prices for Schools, Companies and Institutions
- **Get Special D**iscount on WhatsApp@919896123456

Highlights Brand

- No Brand Name PCB & Projects
- 100% Working
- Tested Project

Documentation

- Printed Short F
- Printable Soft

Support

- Demo Video –
- Technical Supp
- [Get Discount C](#)

[Read More](#)

SKU: PH_SPE_46

Price: ₹568.00 Original price was: ₹568.00. ~~₹335.00~~

Current price is: ₹335.00.

Stock: instock

Categories: [Electronics](#), [General science](#), [Physics](#), [Projects](#), [School Project & Experiment](#)

Product Description



**Electromagnetism
(Faraday's Law)
Electromagnetism
(Using Com)**

Package Inc

Branding Free

- No Brand Name
- PCB & Projects
- 100% Working
- Tested Project

Documentation

- Free Project Sy
- Printed instruc

Support

- Working Video
- Technical Supp
- Get Discount C

[Read More](#)

SKU: PH_SPK_025

Price: ₹440.00 Original price was: ₹440.00. ₹399.00

Current price is: ₹399.00.

Stock: instock

Categories: [Hobby DIY kits](#), [Science Project kit \(SPK\)](#)

Product Description

Download Free Project Synopsis

Working Video

This is a handmade complete working Models, Projects & Activity kits supported by rough study material to make a suitable projects report by the student. It is using Cardboard/Wooden base, Paper, Foam based board, stationary items, Electronic-Electrical Components, Mechanical & Scientific goods as per the requirement of a particular model. Colour of product and decoration item may be varying according to availability of material but we make ensure that we will deliver the product with same working, structure and dimensions as describe in product description section.



Electronic B

Available offer

- **Free Shipping** above Rs999.
- Pay with UPI QR [Coupons](#)
- **Special Bulk D** Companies and
- Get Special Dis 9109087333.

Highlights

Branding Free Pr

- No Brand Name/Logo/Watermark on Components, PCB & Projects
- 100% Working project
- Tested Project & Activity kits

Documentation

- Free Project Synopsis – **Embedded below**
- Printed Short Report
- Printable Soft copy of Project Report

Support

- Demo Video – **Embedded below**
- Technical Support – WhatsApp@9109087333
- [Get Discount Coupon](#)

Delivery Time

- **Handling Period** : 1-2 Days
- **Transit Time** :3-5 Days (Approx.)
- **Delivery Time** : Handling Period + Transit Time (4-7 Days Approx.)

[Read More](#)

SKU: PH_EP_122

Price: ~~₹200.00~~ Original price was: ₹200.00. ₹118.00
Current price is: ₹118.00.

Stock: instock

Categories: [Engineering project](#), [IC & Transistor](#), [Mini Project](#), [Projects](#)

Product Description

Download Free Project Synopsis

Working Video:

Disclaimer:

This is a handmade complete working Models, Projects & Activity kits supported by rough study material to make a suitable projects report by the student. It is using Cardboard/Wooden base, Paper, Foam based board, stationary items, Electronic-Electrical Components, Mechanical & Scientific goods as per the requirement of a particular model. Colour of product and decoration item may be varying according to availability of material but we make ensure that we will deliver the product with same working, structure and dimensions as describe in product description section.



Electronic L

Available offer

- **Free Shipping** above Rs999.
- Pay with UPI QR [Coupons](#)
- **Special Bulk D** Companies and
- Get Special Disc

Highlights

Branding Free Pr

- No Brand Name/ Projects
- 100% Working p
- Tested Project &

Documentation

- Free Project Syn
- Printed Short Re

- Printable Soft copy of Project Report (10-15 Page)

Support

- Demo Video – **Embedded below**
- Technical Support – WhatsApp@9109087333
- [Get Discount Coupon](#)

[Read More](#)

SKU: PH_EP_043

Price: ~~₹460.00~~ Original price was: ₹460.00. ₹271.00
Current price is: ₹271.00.

Stock: instock

Categories: [Engineering project](#), [IC & Transistor](#), [Mini Project](#), [Projects](#)

Product Description

Download Free Project Synopsis

Working Video

Disclaimer:

This is a handmade complete working Models, Projects & Activity kits supported by rough study material to make a suitable projects report by the student. It is using Cardboard/Wooden base, Paper, Foam based board, stationary items, Electronic-Electrical Components, Mechanical & Scientific goods as per the requirement of a particular model. Colour of product and decoration item may be varying according to availability of material but we make ensure that we will deliver the product with same working, structure and dimensions as describe in product description section.



Electronic Voting Machine (EVM) with Separated Switch Panel

Package Includes:

Branding Free Project / Activity kit

- No Brand Name/Logo/Watermark on Components, PCB & Projects
- 100% Working project
- Tested Project & Activity kits

Documentation

- Free Project Synopsis – ***Embedded below***
- Printed instruction booklet

Support

- Working Video – ***Embedded Below***
- Technical Support – WhatsApp@9109087333
- Get Discount Coupon – WhatsApp@9303254433

[Read More](#)

SKU: PH_EP_057

Price: ~~₹3,800.00~~ Original price was: ₹3,800.00. ₹2,250.00 Current price is: ₹2,250.00.

Stock: instock

Categories: [Arduino](#), [Engineering project](#), [Exhibition Models & Inspire Award](#), [Projects](#), [Technology & Innovation](#)

Tags: [school science project](#), [science exhibition model](#), [security system](#)

Product Description

Download Free Project Synopsis

Working Video

This is a handmade complete working Models, Projects & Activity kits supported by rough study material to make a suitable projects report by the student. It is using Cardboard/Wooden base, Paper, Foam based board, stationary items, Electronic-Electrical Components, Mechanical & Scientific goods as per the requirement of a particular model. Colour of product and decoration item may be varying according to availability of material but we make ensure that we will deliver the product with same working, structure and dimensions as describe in product description section.

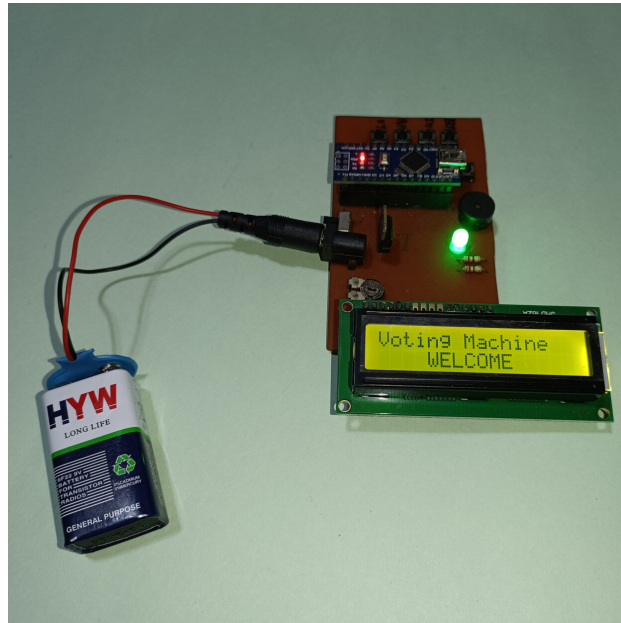

Electronic V Arduino

Available offer

- **Free Shipping** above Rs999.
- Pay with UPI QR [Coupons](#)
- **Special Bulk D** Companies and r
- Get Special Dis 9109087333.

Highlights

Branding Free Pr

- No Brand Name/ Projects
- 100% Working p
- Tested Project &

Documentation

- Free Project Synopsis – **Embedded below**
- Printed Short Report
- Printable Soft copy of Project Report

Support

- Demo Video – **Embedded below**
- Technical Support – WhatsApp@9109087333
- [Get Discount Coupon](#)

Delivery Time

- **Handling Period** : 1-2 Days
- **Transit Time** :3-5 Days (Approx.)
- **Delivery Time** : Handling Period + Transit Time (4-7 Days Approx.)

[Read More](#)

SKU: PH_EP_008

Price: ~~₹2,624.00~~ Original price was: ₹2,624.00.₹
1,548.00Current price is: ₹1,548.00.

Stock: instock

Categories: [Arduino](#), [Engineering project](#), [Projects](#)

Product Description

Download Free Project Synopsis

Working Video

This is a handmade complete working Models, Projects & Activity kits supported by rough study material to make a suitable projects report by the student. It is using Cardboard/Wooden base, Paper, Foam based board, stationary items, Electronic-Electrical Components, Mechanical & Scientific goods as per the requirement of a particular model. Colour of product and decoration item may be varying according to availability of material but we make ensure that we will deliver the product with same working, structure and dimensions as describe in product description section.



Electroplating process

Kit Includes:

- **Project Kit**
- **9V Battery**
- **Print Short R**

Available offers:

- **Free Shipping**
orders above ₹
- **Pay with UPI**
Discount./[Cou](#)
- **Special Bulk**
Companies an
- **Get Special D**
WhatsApp@91

Highlights Brand

- No Brand Name
PCB & Projects
- 100% Working
- Tested Project

Documentation

- Printed Short F
- Printable Soft

Support

- Demo Video –
- Technical Supp
- [Get Discount C](#)

[Read More](#)

SKU: PH_SPE_44

Price:

Stock: instock

Categories: [Electronics](#), [General science](#), [Physics](#), [Projects](#), [School Project & Experiment](#)

Product Description

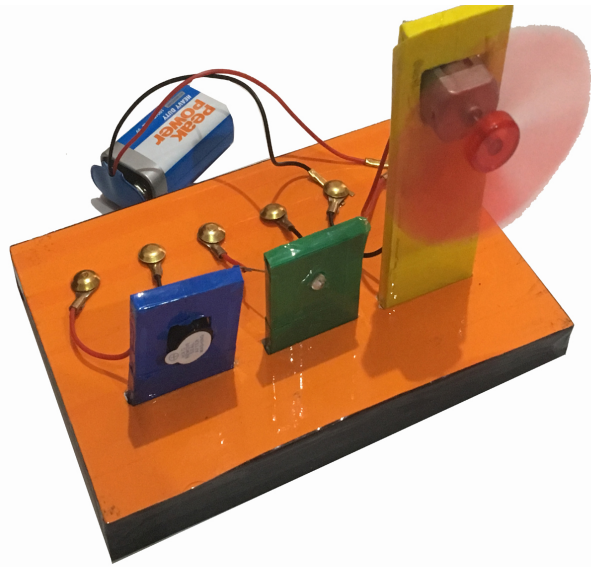

Energy Conversion Experiment

Package Includes:

Branding Free Project / Activity kit

- No Brand Name/Logo/Watermark on Components, PCB & Projects
- 100% Working project
- Tested Project & Activity kits

Documentation

- Free Project Synopsis – ***Embedded below***
- Printed instruction booklet

Support

- Working Video – ***Embedded Below***
- Technical Support – WhatsApp@9109087333
- Get Discount Coupon – WhatsApp@9303254433

[Read More](#)

SKU: PH_SPK_015

Price: ~~₹400.00~~ Original price was: ₹400.00. ₹360.00
Current price is: ₹360.00.

Stock: instock

Categories: [Hobby DIY kits](#), [Science Project kit \(SPK\)](#)

Product Description

Download Free Project Synopsis

Working Video

This is a handmade complete working Models, Projects & Activity kits supported by rough study material to make a suitable projects report by the student. It is using Cardboard/Wooden base, Paper, Foam based board, stationary items, Electronic-Electrical Components, Mechanical & Scientific goods as per the requirement of a particular model. Colour of product and decoration item may be varying according to availability of material but we make ensure that we will deliver the product with same working, structure and dimensions as describe in product description section.



Eveready 9V Battery High-Quality Battery

Available offers:

- **Free Shipping Offer** - Avail free shipping on all orders above Rs999.
- COD available in almost all product categories on order above 999.
- Pay with UPI QR Code & **Get 5% Special Discount./ [Coupons](#)**
- **Special Bulk Discounts** - for colleges, Schools, Companies and resellers./ [Contact Us](#).
- Get Special Discount Coupon - WhatsApp@9303254433.

[Read More](#)

SKU: PH_COM_234

Price: ₹45.00 Original price was: ₹45.00. ~~₹42.00~~

Current price is: ₹42.00.

Stock: instock

Categories: [Basic Components](#), [Batteries & Power Source](#), [Components & Spares](#)

Product Description

Brand: Eveready

Battery Cell Composition: Zinc Carbon

Compatible Phone Models: Radio

Recommended Uses For Product: Science Activity, Radio, Camera, Clock, Cordless Mic etc.



Factors Affecting Resistance (Cu and Al Wire)

Package Includes:

Branding Free Activity kit

- No Brand Name/Logo/Watermark on Components, PCB & Projects
- Tested Activity kits

Documentation

- Free Project Synopsis – **Embedded below**
- Printed instruction booklet

Support

- Working Video – **Embedded Below**
- Technical Support – WhatsApp@9109087333
- Get Discount Coupon – WhatsApp@9303254433

[Read More](#)

SKU: PH_SPE_49

Price: ~~₹560.00~~ Original price was: ₹560.00. ₹330.00
Current price is: ₹330.00.

Stock: instock

Categories: [Electricity & Magnetism](#), [Electronics](#), [Physics](#), [Projects](#), [School Project & Experiment](#)

Tags: [class 12th science project and experiment](#), [new science project](#)

Product Description

Download Free Project Synopsis

Disclaimer

This is a handmade complete working Models, Projects & Activity kits supported by rough study material to make a suitable projects report by the student. It is using Cardboard/Wooden base, Paper, Foam based board, stationary items, Electronic-Electrical Components, Mechanical & Scientific goods as per the requirement of a particular model. Colour of product and decoration item may be varying according to availability of material but we make ensure that we will deliver the product with same working, structure and dimensions as describe in product description section.

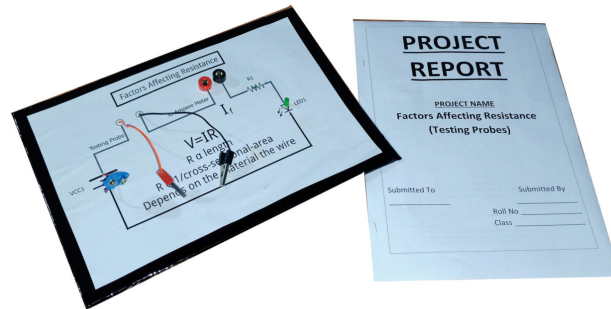

Factors Affecting Resistance (testing probes)

Package Includes

Branding Free

- No Brand Name
- PCB & Projects
- Tested Activity

Documentation

- Free Project Synopsis
- Printed instructions

Support

- Working Video
- Technical Support
- Get Discount Code

[Read More](#)

SKU: PH_SPE_50

Price: ₹436.00 Original price was: ₹436.00. ~~₹257.00~~
Current price is: ₹257.00.

Stock: instock

Categories: [Electricity & Magnetism](#), [Electronics](#), [Physics](#), [Projects](#), [School Project & Experiment](#)

Tags: [class 12th science project and experiment](#), [new science project](#)

Product Description

Download Free Project Synopsis

Disclaimer

This is a handmade complete working Models, Projects & Activity kits supported by rough study material to make a suitable projects report by the student. It is using Cardboard/Wooden base, Paper, Foam based board, stationary items, Electronic-Electrical Components, Mechanical & Scientific goods as per the requirement of a particular model. Colour of product and decoration item may be varying according to availability of material but we make ensure that we will deliver the product with same working, structure and dimensions as describe in product description section.

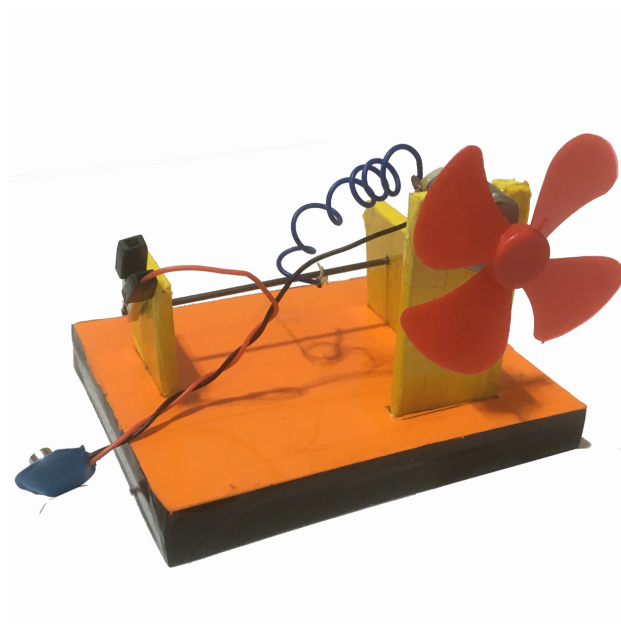

Fan Speed Control
Graphite as

Package Inc

Branding Free

- No Brand Name
- PCB & Projects
- 100% Working
- Tested Project

Documentation

- Free Project Synopsis – ***Embedded below***
- Printed instruction booklet

Support

- Working Video – ***Embedded Below***
- Technical Support – WhatsApp@9109087333
- Get Discount Coupon – WhatsApp@9303254433

[Read More](#)

SKU: PH_SPK_044

Price: ~~₹340.00~~ Original price was: ₹340.00. ₹299.00
Current price is: ₹299.00.

Stock: instock

Categories: [Hobby DIY kits](#), [Science Project kit \(SPK\)](#)

Product Description

Download Free Project Synopsis

Working Video

This is a handmade complete working Models, Projects & Activity kits supported by rough study material to make a suitable projects report by the student. It is using Cardboard/Wooden base, Paper, Foam based board, stationary items, Electronic-Electrical Components, Mechanical & Scientific goods as per the requirement of a particular model. Colour of product and decoration item may be varying according to availability of material but we make ensure that we will deliver the product with same working, structure and dimensions as describe in product description section.

Faraday's L Electromag



Kit Includes:

- **Project Kit**
- **9V Battery**
- **Print Short R**

Available offers:

- **Free Shipping**
orders above ₹
- **Pay with UPI**
Discount./[Cou](#)
- **Special Bulk**
Companies an
- **Get Special D**
WhatsApp@91

Highlights Brand

- No Brand Nam
- PCB & Projects
- 100% Working
- Tested Project

Documentation

- Printed Short F
- Printable Soft

Support

- Demo Video –
- Technical Supp
- [Get Discount C](#)

[Read More](#)

SKU: PH_SPE_52

Price: ~~₹584.00~~ Original price was: ₹584.00. ₹345.00

Current price is: ₹345.00.

Stock: instock

Categories: [Electronics](#), [General science](#), [Physics](#),
[Projects](#), [School Project & Experiment](#)

Product Description
