

Wifi Control using blynk (IOT) (4-Cha

Available offer

- **Free Shipping** above Rs999.
- Pay with UPI QR [Coupons](#)
- **Special Bulk D** Companies and
- Get Special Dis 9109087333.

Highlights

Branding Free Pr

- No Brand Name/ Projects
- 100% Working p
- Tested Project &

Documentation

- Free Project Syn
- Printed Short Re
- Printable Soft co

Support

- Demo Video – **E**
- Technical Suppo
- [Get Discount Co](#)

Delivery Time

- **Handling Period** : 2-3 Days
- **Transit Time** :3-5 Days (Approx.)
- **Delivery Time** : Handling Period + Transit Time (5-8 Days Approx.)

[Read More](#)

SKU: PH_EP_011

Price: ~~₹4,292.00~~ Original price was: ₹4,292.00. ₹
2,532.00 Current price is: ₹2,532.00.

Stock: instock

Categories: [Android / Smartphone Controlled](#),
[Engineering project](#), [IOT](#), [NodeMCU](#), [Projects](#)

Product Description

Download Free Project Synopsis

Working Video

This is a handmade complete working Models, Projects & Activity kits supported by rough study material to make a suitable projects report by the student. It is using Cardboard/Wooden base, Paper, Foam based board, stationary items, Electronic-Electrical Components, Mechanical & Scientific goods as per the requirement of a particular model. Colour of product and decoration item may be varying according to availability of material but we make ensure that we will deliver the product with same working, structure and dimensions as describe in product description section.



Wind Energy based Outdoor Garden Light

Package Includes:

Branding Free Project / Activity kit

- No Brand Name/Logo/Watermark on Components, PCB & Projects
- 100% Working project
- Tested Project & Activity kits

Documentation

- Free Project Synopsis – ***Embedded below***
- Printed instruction booklet

Support

- Working Video – ***Embedded Below***
- Technical Support – WhatsApp@9109087333
- Get Discount Coupon – WhatsApp@9303254433

[Read More](#)

SKU: PH_SEM_10

Price: ₹848.00 Original price was: ₹848.00. ~~₹500.00~~
Current price is: ₹500.00.

Stock: instock

Categories: [Energy](#), [Exhibition Models & Inspire Award](#), [Technology & Innovation](#)

Tags: [school science project](#), [science exhibition model](#), [security system](#)

Product Description

Download Free Project Synopsis

This is a handmade complete working Models, Projects & Activity kits supported by rough study material to make a suitable projects report by the student. It is using Cardboard/Wooden base, Paper, Foam based board, stationary items, Electronic-Electrical Components, Mechanical & Scientific goods as per the requirement of a particular model. Colour of product and decoration item may be varying according to availability of material but we make ensure that we will deliver the product with same working, structure and dimensions as describe in product description section.



Wind Energy

Package Inc

Branding Free

- No Brand Name
- PCB & Projects
- 100% Working
- Tested Project

Documentation

- Free Project Sy
- Printed instruc

Support

- Working Video
- Technical Supp
- Get Discount C

[Read More](#)

SKU: PH_SEM_09

Price: ₹848.00 Orig
Current price is: ₹5

Stock: instock

Categories: [Agricu](#)
, [Exhibition Models](#)

Tags: [school science project](#), [science exhibition model](#), [security system](#)

Product Description

Download Free Project Synopsis

This is a handmade complete working Models, Projects & Activity kits supported by rough study material to make a suitable projects report by the student. It is using Cardboard/Wooden base, Paper, Foam based board, stationary items, Electronic-Electrical Components, Mechanical & Scientific goods as per the requirement of a particular model. Colour of product and decoration item may be varying according to availability of material but we make ensure that we will deliver the product with same working, structure and dimensions as describe in product description section.

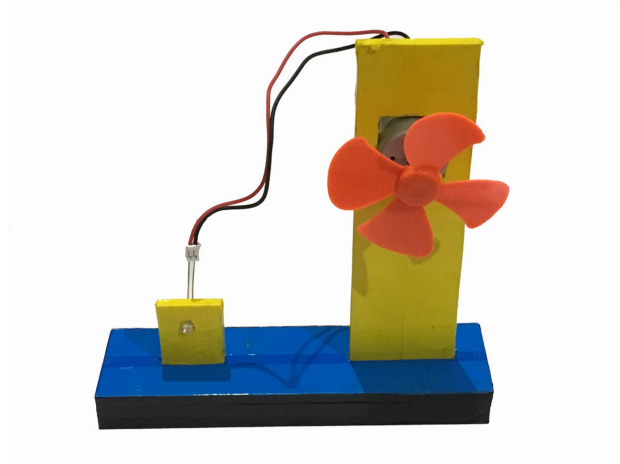

Wind Mill E

Package Inc

Branding Free

- No Brand Name
- PCB & Projects
- 100% Working
- Tested Project

Documentation

- Free Project Sy
- Printed instruc

Support

- Working Video
- Technical Supp
- Get Discount C

[Read More](#)

SKU: PH_SPK_001

Price: ₹300.00 Original price was: ₹300.00. ₹260.00

Current price is: ₹260.00.

Stock: instock

Categories: [Hobby DIY kits](#), [Science Project kit \(SPK\)](#)

Product Description

[Download Free Project Synopsis](#)

Working Video

This is a handmade complete working Models, Projects & Activity kits supported by rough study material to make a suitable projects report by the student. It is using Cardboard/Wooden base, Paper, Foam based board, stationary items, Electronic-Electrical Components, Mechanical & Scientific goods as per the requirement of a particular model. Colour of product and decoration item may be varying according to availability of material but we make ensure that we will deliver the product with same working, structure and dimensions as describe in product description section.

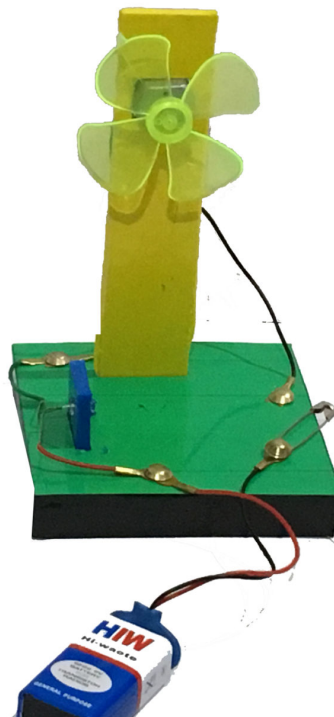

Wind Mill W

Package Inc

Branding Free

- No Brand Name
- PCB & Projects
- 100% Working
- Tested Project

Documentation

- Free Project Sy
- Printed instruc

Support

- Working Video – ***Embedded Below***
- Technical Support – WhatsApp@9109087333
- Get Discount Coupon – WhatsApp@9303254433

[Read More](#)

SKU: PH_SPK_011

Price: ~~₹360.00~~ Original price was: ₹360.00. ₹320.00
Current price is: ₹320.00.

Stock: instock

Categories: [Hobby DIY kits](#), [Science Project kit \(SPK\)](#)

Product Description

Download Free Project Synopsis

Working Video

This is a handmade complete working Models, Projects & Activity kits supported by rough study material to make a suitable projects report by the student. It is using Cardboard/Wooden base, Paper, Foam based board, stationary items, Electronic-Electrical Components, Mechanical & Scientific goods as per the requirement of a particular model. Colour of product and decoration item may be varying according to availability of material but we make ensure that we will deliver the product with same working, structure and dimensions as describe in product description section.



**Wired remo
using DPDT
gear motor**

Available offer

- **Free Shipping**
orders above ₹

- Pay with UPI QR Code & **Get 5%** Special Discount./ [Coupons](#)
- **Special Bulk Discounts** - for colleges, Schools, Companies and resellers./ [Contact Us](#).
- Get Special Discount Coupon - WhatsApp@9109087333.

Highlights

Branding Free Project / Activity kit

- No Brand Name/Logo/Watermark on Components, PCB & Projects
- 100% Working project
- Tested Project & Activity kits

Documentation

- Free Project Synopsis – **Embedded below**
- Printed Short Report
- Printable Soft copy of Project Report

Support

- Demo Video – **Embedded below**
- Technical Support – WhatsApp@9109087333
- [Get Discount Coupon](#)

Delivery Time

- **Handling Period** : 1-2 Days
- **Transit Time** :3-5 Days (Approx.)
- **Delivery Time** : Handling Period + Transit Time (4-7 Days Approx.)

Click Here to Buy Do It Yourself Kit

[Read More](#)

SKU: PH_EP_096

Price:

Stock: instock

Categories: [Engineering project](#), [Mechanical](#), [Projects](#), [Robotics](#)

Product Description

Download Free Project Synopsis

Working Video

Disclaimer:

This is a handmade complete working Models, Projects & Activity kits supported by rough study material to make a suitable projects report by the student. It is using Cardboard/Wooden base, Paper, Foam based board, stationary items, Electronic-Electrical Components, Mechanical & Scientific goods as per the requirement of a particular model. Colour of product and decoration item may be varying according to availability of material but we make ensure that we will deliver the product with same working, structure and dimensions as describe in product description section.

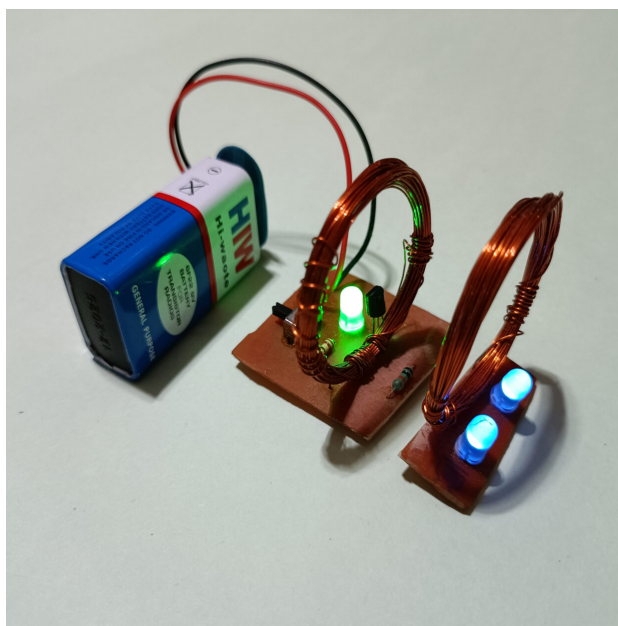

Wireless Energy Transfer PCB

Available offer

- **Free Shipping** above Rs999.
- COD available in above 999.
- Pay with UPI QR [Coupons](#)
- **Special Bulk Discount** Companies and
- Get Special Discount

Highlights

Branding Free Project / Activity kit

- No Brand Name/Logo/Watermark on Components, PCB & Projects
- 100% Working project
- Tested Project & Activity kits

Documentation

- Free Project Synopsis - **Embedded below**
- Printed Short Report
- Printable Soft copy of Project Report

Support

- Demo Video - **Embedded below**
- Technical Support - WhatsApp@9109087333
- [Get Discount Coupon](#)

Click Here to Buy Do It Yourself Kit

[Read More](#)

SKU: PH_EP_026

Price: ~~₹396.00~~ Original price was: ₹396.00. ₹234.00
Current price is: ₹234.00.

Stock: instock

Categories: [Engineering project](#), [IC & Transistor](#), [Mini Project](#), [Projects](#)

Product Description

INTRODUCTION:

Wireless power transmission is a technology that enables the transfer of electrical energy from a power source to an electrical device without the need for physical wires or direct electrical contact. While there are more complex and advanced methods of wireless power transmission, I will outline a simple approach using electromagnetic induction.

APPLICATION:

Wireless energy transmission has various applications across different industries and fields. Here are some notable applications:

1. **Wireless Charging of Devices:** One of the most common applications of wireless energy transmission is in wireless charging of devices such as smartphones, tablets, smartwatches, and wireless earbuds. This technology eliminates the need for physical cables and allows for convenient and efficient charging.
2. **Electric Vehicle Charging:** Wireless energy transmission is also being used to charge electric vehicles (EVs) wirelessly. This technology enables the charging of EVs by simply parking them over a wireless charging pad, eliminating the need for physical charging cables.

These are just a few examples of the diverse applications of wireless energy transmission. As technology continues to advance, we can expect to see more innovative applications in various industries and fields. **ADVANTAGES:**

1. **Convenience:** Wireless power transmission eliminates the need for physical wires, allowing for easier device charging or power supply without the hassle of plugging and unplugging cables.
2. **Flexibility:** Devices can be charged or powered without the limitation of cable length, providing more flexibility in device placement and movement.
3. **Safety:** Wireless power transmission eliminates the risk of electric shock or short circuits due to exposed wires.
4. **Reduced wear and tear:** By eliminating physical connectors, there is less wear and tear on device charging ports, resulting in increased durability.

[Download Free Project Synopsis](#)

Working Video

Disclaimer:

This is a handmade complete working Models, Projects & Activity kits supported by rough study material to make a suitable projects report by the student. It is using Cardboard/Wooden base, Paper, Foam based board, stationary items, Electronic-Electrical Components, Mechanical & Scientific goods as per the requirement of a particular model. Colour of product and decoration

item may be varying according to availability of material but we make ensure that we will deliver the product with same working, structure and dimensions as describe in product description section.



Wireless Power Transmission / Wireless Energy transmission

Package Includes:

Branding Free Project / Activity kit

- No Brand Name/Logo/Watermark on Components, PCB & Projects
- 100% Working project
- Tested Project & Activity kits

Documentation

- Free Project Synopsis – **Embedded below**
- Printed instruction booklet
- Printable Soft copy of Project Report
- PPT

Support

- Demo Video – **Embedded below**
- Technical Support – WhatsApp@9109087333
- Get Discount Coupon – WhatsApp@9303254433

[Read More](#)

SKU: PH_EP_094

Price: ~~₹328.00~~ Original price was: ₹328.00. ₹194.00
Current price is: ₹194.00.

Stock: instock

Categories: [Energy](#), [Engineering project](#), [Exhibition Models & Inspire Award](#), [IC & Transistor](#), [Mini Project](#), [Projects](#), [Technology & Innovation](#)

Product Description

Download Free Project Synopsis

Working Video

This is a handmade complete working Models, Projects & Activity kits supported by rough study material to make a suitable projects report by the student. It is using Cardboard/Wooden base, Paper, Foam based board, stationary items, Electronic-Electrical Components, Mechanical & Scientific goods as per the requirement of a particular model. Colour of product and decoration item may be varying according to availability of material but we make ensure that we will deliver the product with same working, structure and dimensions as describe in product description section.



Wooden small home, 3D DIY Paper folding home, best for school project

Support

- Demo Video – [Embedded below](#)
- Technical Support – WhatsApp@9109087333
- Get Discount Coupon – WhatsApp@9303254433

[Read More](#)

SKU: PH_DG_003

Price: ~~₹20.00~~ Original price was: ₹20.00. ₹5.00 Current price is: ₹5.00.

Stock: instock

Categories: [Digital Products](#), [Printable Templates](#)

Product Description

XNOR Logic Gate using Switch

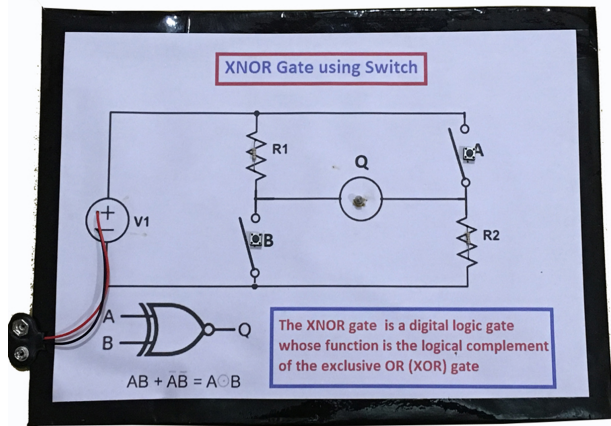

Package Includes:

Branding Free Activity kit

- No Brand Name/Logo/Watermark on Components, PCB & Projects
- Tested Activity kits

Documentation

- Free Project Synopsis – **Embedded below**
- Printed instruction booklet

Support

- Working Video – **Embedded Below**
- Technical Support – WhatsApp@9109087333
- Get Discount Coupon – WhatsApp@9303254433

[Read More](#)

SKU: PH_SPE_136

Price: ~~₹200.00~~ Original price was: ₹200.00. ₹180.00
Current price is: ₹180.00.

Stock: instock

Categories: [Electronics](#), [Logic Gate](#), [Physics](#), [Projects](#), [School Project & Experiment](#)

Tags: [class 12th science project and experiment](#), [logic gate](#), [new science project](#)

Product Description

Download Free Project Synopsis

Disclaimer

This is a handmade complete working Models, Projects & Activity kits supported by rough study material to make a suitable projects report by the student. It is using Cardboard/Wooden base, Paper, Foam based board, stationary items, Electronic-Electrical Components, Mechanical & Scientific goods as per the requirement of a particular model. Colour of product and decoration item may be varying according to availability of material but we make ensure that we will deliver the product with same working, structure and dimensions as describe in product description section.

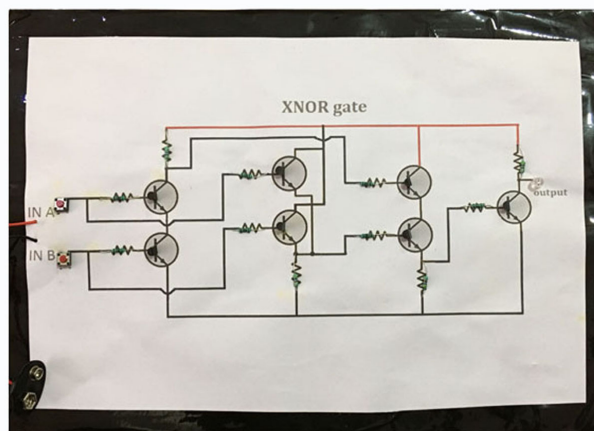

XNOR Logic Transistors

Package Includ

Branding Free

- No Brand Name
- PCB & Projects
- Tested Activity

Documentation

- Free Project Sy
- Printed instruc

Support

- Working Video
- Technical Supp
- Get Discount C

[Read More](#)

SKU: PH_SPE_137

Price: ₹240.00 Orig
Current price is: ₹2

Stock: instock

Categories: [Electr](#)
[School Project & Ex](#)

Tags: [class 12th science project and experiment](#), [logic gate](#), [new science project](#)

Product Description

Download Free Project Synopsis

Disclaimer

This is a handmade complete working Models, Projects & Activity kits supported by rough study material to make a suitable projects report by the student. It is using Cardboard/Wooden base, Paper, Foam based board, stationary items, Electronic-Electrical Components, Mechanical & Scientific goods as per the requirement of a particular model. Colour of product and decoration item may be varying according to availability of material but we make ensure that we will deliver the product with same working, structure and dimensions as describe in product description section.

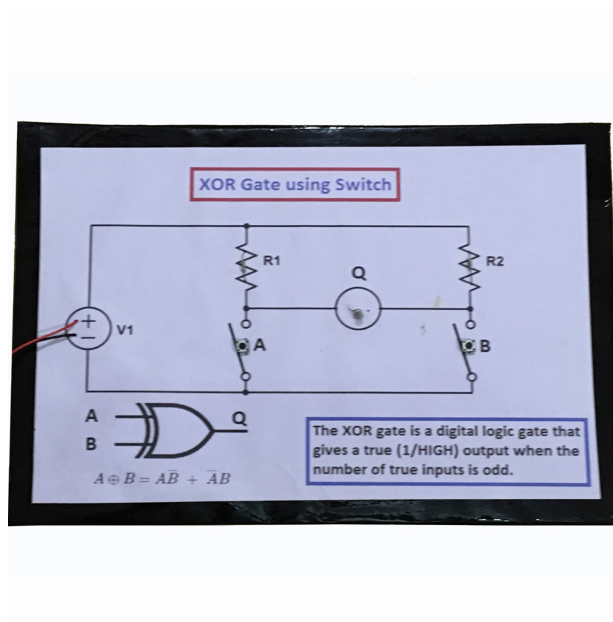

XOR Logic C

Package Includ

Branding Free

- No Brand Name
- PCB & Projects
- Tested Activity

Documentation

- Free Project Sy
- Printed instruc

Support

- Working Video
- Technical Supp
- Get Discount C

[Read More](#)

SKU: PH_SPE_138

Price: ₹200.00 Original price was: ₹200.00. ~~₹180.00~~

Current price is: ₹180.00.

Stock: instock

Categories: [Electronics](#), [Logic Gate](#), [Physics](#), [Projects](#), [School Project & Experiment](#)

Tags: [class 12th science project and experiment](#), [logic gate](#), [new science project](#)

Product Description

Download Free Project Synopsis

Disclaimer

This is a handmade complete working Models, Projects & Activity kits supported by rough study material to make a suitable projects report by the student. It is using Cardboard/Wooden base, Paper, Foam based board, stationary items, Electronic-Electrical Components, Mechanical & Scientific goods as per the requirement of a particular model. Colour of product and decoration item may be varying according to availability of material but we make ensure that we will deliver the product with same working, structure and dimensions as describe in product description section.

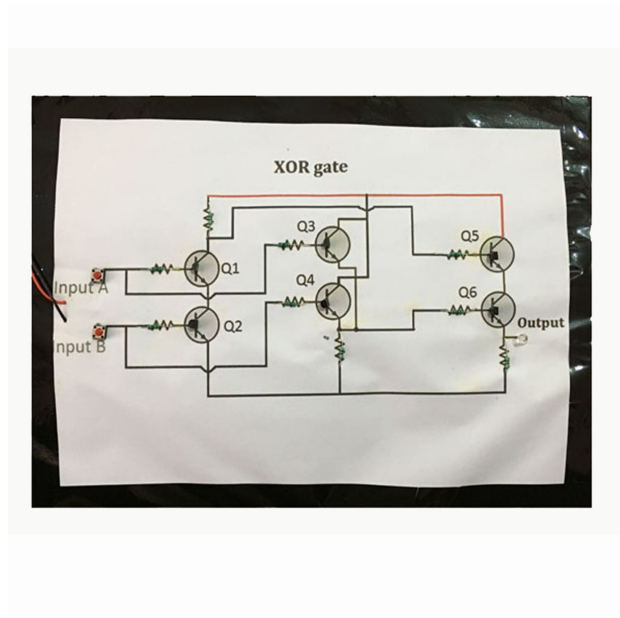

XOR Logic C Transistors

Package Includ

Branding Free

- No Brand Nam
- PCB & Projects
- Tested Activity

Documentation

- Free Project Synopsis – **Embedded below**
- Printed instruction booklet

Support

- Working Video – **Embedded Below**
- Technical Support – WhatsApp@9109087333
- Get Discount Coupon – WhatsApp@9303254433

[Read More](#)

SKU: PH_SPE_139

Price: ~~₹240.00~~ Original price was: ₹240.00. ₹210.00
Current price is: ₹210.00.

Stock: instock

Categories: [Electronics](#), [Logic Gate](#), [Physics](#), [Projects](#), [School Project & Experiment](#)

Tags: [class 12th science project and experiment](#), [logic gate](#), [new science project](#)

Product Description

Download Free Project Synopsis

Disclaimer

This is a handmade complete working Models, Projects & Activity kits supported by rough study material to make a suitable projects report by the student. It is using Cardboard/Wooden base, Paper, Foam based board, stationary items, Electronic-Electrical Components, Mechanical & Scientific goods as per the requirement of a particular model. Colour of product and decoration item may be varying according to availability of material but we make ensure that we will deliver the product with same working, structure and dimensions as describe in product description section.

DIY 3D HOME



PAPER
FOLDING
HOUSE



Download



Print



Fold



Enjoy

Yellow small home, 3D DIY Paper folding home, Craft Kit for Kids

Support

- Demo Video – [Embedded below](#)
- Technical Support – WhatsApp@9109087333
- Get Discount Coupon – WhatsApp@9303254433

[Read More](#)

SKU: PH_DG_002

Price: ~~₹20.00~~ Original price was: ₹20.00. ₹5.00 Current price is: ₹5.00.

Stock: instock

Categories: [Digital Products](#), [Printable Templates](#)

Product Description

Zener as Vo

Kit Includes:

- Project Kit
- 9V Battery
- Print Short R

Available offers:

- Free Shipping on orders above ₹
- Pay with UPI for 5% Discount./[Cou](#)
- Special Bulk Discounts for Companies an



- **Get Special Discount Coupon** –
WhatsApp@9109087333.

Highlights Branding Free Project / Activity kit

- No Brand Name/Logo/Watermark on Components, PCB & Projects
- 100% Working project
- Tested Project & Activity kits

Documentation

- Printed Short Report
- Printable Soft copy of Project Report

Support

- Demo Video – **Embedded below**
- Technical Support – WhatsApp@9109087333
- [Get Discount Coupon](#)

[Read More](#)

SKU: PH_SPE_140

Price:

Stock: instock

Categories: [Electronics](#), [General science](#), [Physics](#), [Projects](#), [School Project & Experiment](#)

Product Description



Zener regul

Kit Includes:

- **Project Kit**
- **9V Battery**
- **Print Short R**

Available offers:

- **Free Shipping**
orders above ₹
- **Pay with UPI**
Discount./[Coupo](#)
- **Special Bulk**
Companies an
- **Get Special D**
WhatsApp@91

Highlights Brand

- No Brand Nam
- PCB & Projects
- 100% Working
- Tested Project

Documentation

- Printed Short F
- Printable Soft

Support

- Demo Video –
- Technical Supp
- [Get Discount C](#)

[Read More](#)

SKU: PH_SPE_141

Price:

Stock: instock

Categories: [Electronics](#), [General science](#), [Physics](#),
[Projects](#), [School Project & Experiment](#)

Product Description
