



## Solar Power

### Available offer

- **Free Shipping** above Rs999.
- Pay with UPI QR [Coupons](#)
- **Special Bulk D** Companies and
- Get Special Disc

### Highlights

#### Branding Free Pr

- No Brand Name/ Projects
- 100% Working p
- Tested Project &

#### Documentation

- Free Project Syn
- Printed Short Re
- Printable Soft co

#### Support

- Demo Video – **E**
- Technical Suppo
- [Get Discount Co](#)

Click Here to Buy D

Digital Bundle Click

- Printable Soft co
- Printable Soft co

[Read More](#)

**SKU:** PH\_EP\_038

**Price:** ~~₹3,196.00~~ Original price was: ₹3,196.00. ₹1,886.00 Current price is: ₹1,886.00.

**Stock:** instock

**Categories:** [Energy](#), [Engineering project](#), [Exhibition Models & Inspire Award](#), [IC & Transistor](#), [Projects](#), [Solar](#)

## Product Description

### Disclaimer:

This is a handmade complete working Models, Projects & Activity kits supported by rough study material to make a suitable projects report by the student. It is using Cardboard/Wooden base, Paper, Foam based board, stationary items, Electronic-Electrical Components, Mechanical & Scientific goods as per the requirement of a particular model. Colour of product and decoration item may be varying according to availability of material but we make ensure that we will deliver the product with same working, structure and dimensions as describe in product description section.

## Solder Wire - 10gm (Good Quality)

[Read More](#)

**SKU:** PH\_TI\_010

**Price:** ~~₹50.00~~ Original price was: ₹50.00. ₹20.00 Current price is: ₹20.00.

**Stock:** instock

**Categories:** [Electronic Lab](#), [Tools & Laboratory Instruments](#)



## Product Description

Solder Wire 10gm is useful if you want to join components and wires, over your PCB. Complete your circuit and join electrically your components through this solder or soldering wire. Solder is a fusible metal alloy used to join together metal workpieces and having a melting point below that of the workpiece(s). Soft solder is typically thought of when solder or soldering is mentioned, with a typical melting range of 90 to 450 °C . It is commonly used in electronics, plumbing, and assembly of sheet metal parts. Manual soldering uses a soldering iron or soldering gun. Alloys that melt between 180 and 190 °C (360 and 370 °F) are the most commonly used. Soldering performed using alloys with a melting point above 450 °C (840 °F) is called brazing.

### Features and Specifications:

- Good solderability both in electrical conductivity and thermal conductivity.
- High activity flux makes more reliable soldering and leaves bright shiny solder joints after reflow.
- With the solder wire reel, soldering can be accomplished quickly.
- Widely applied in electrical repairs.
- Net Weight: 10g



## Soldering Iron Stand

[Read More](#)

**SKU:** PH\_TI\_007

**Price:** ₹100.00 Original price was: ₹100.00. ~~₹70.00~~  
Current price is: ₹70.00.

**Stock:** instock

**Categories:** [Electronic Lab](#), [Tools & Laboratory Instruments](#)

## Product Description

This is a stable well supported metal base low cost soldering iron stand. It can hold, most of the pen-type soldering iron with its spring holder. A sponge for cleaning the iron comes attached to

the base.

## Features:

- Ideal for both hobbyists and professional users
- Suitable for use with most soldering irons
- Includes a sponge tray for cleaning the soldering iron tip
- Double spiral spring construction makes it virtually impossible to accidentally touch the iron when inserted into the stand
- Good and Stable quality
- Excellent after-sold service
- Safety

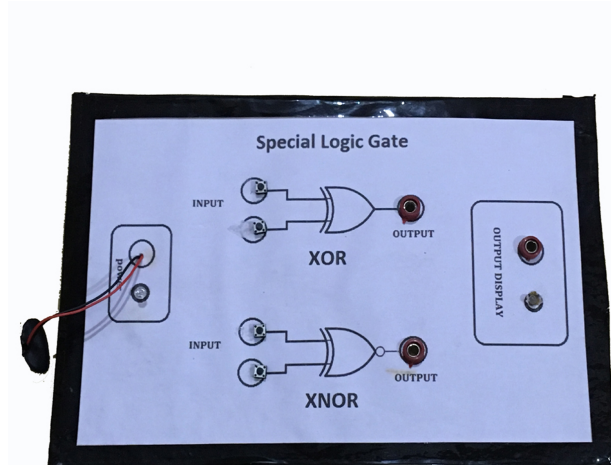

## Special Log

### Kit Includes:

- Project Kit
- 9V Battery
- Print Short R

### Available offers:

- Free Shipping on orders above ₹
- Pay with UPI for 5% Discount./[Coup](#)
- Special Bulk Discounts for Companies and
- Get Special D on WhatsApp@91

### Highlights Brand

- No Brand Name PCB & Projects
- 100% Working
- Tested Project

### Documentation

- Printed Short Report
- Printable Soft copy of Project Report

### Support

- Demo Video – **Embedded below**
- Technical Support – WhatsApp@9109087333
- [Get Discount Coupon](#)

[Read More](#)

**SKU:** PH\_SPE\_111

**Price:** ~~₹600.00~~ Original price was: ₹600.00. ₹560.00  
Current price is: ₹560.00.

**Stock:** instock

**Categories:** [Electronics](#), [Logic Gate](#), [Physics](#), [Projects](#), [School Project & Experiment](#)

**Tags:** [class 12th science project and experiment](#), [logic gate](#), [new science project](#)

## Product Description

## Download Free Project Synopsis

### Disclaimer

This is a handmade complete working Models, Projects & Activity kits supported by rough study material to make a suitable projects report by the student. It is using Cardboard/Wooden base, Paper, Foam based board, stationary items, Electronic-Electrical Components, Mechanical & Scientific goods as per the requirement of a particular model. Colour of product and decoration item may be varying according to availability of material but we make ensure that we will deliver the product with same working, structure and dimensions as describe in product description section.

---



## Step Down (Made)

### Kit Includes:

- **Project Kit**
- **9V Battery**
- **Print Short R**

### Available offers:

- **Free Shipping**  
orders above ₹
- **Pay with UPI**  
Discount./[Cou](#)
- **Special Bulk**  
Companies an
- **Get Special D**  
WhatsApp@91

### Highlights Brand

- No Brand Name  
PCB & Projects
- 100% Working
- Tested Project

### Documentation

- Printed Short F
- Printable Soft

### Support

- Demo Video –
- Technical Supp
- [Get Discount C](#)

[Read More](#)

**SKU:** PH\_SPE\_112

**Price:**

**Stock:** instock

**Categories:** [Electronics](#), [General science](#), [Physics](#), [Projects](#), [School Project & Experiment](#)

## Product Description

---



## Step Down Experiment

### Kit Includes:

- **Project Kit**
- **9V Battery**
- **Print Short R**

### Available offers:

- **Free Shipping**  
orders above ₹
- **Pay with UPI**  
Discount./[Coup](#)
- **Special Bulk**  
Companies an
- **Get Special D**  
WhatsApp@91

### Highlights Brand

- No Brand Name  
PCB & Projects
- 100% Working
- Tested Project

### Documentation

- Printed Short F
- Printable Soft

### Support

- Demo Video – **Embedded below**
- Technical Support – WhatsApp@9109087333
- [Get Discount Coupon](#)

[Read More](#)

**SKU:** PH\_SPE\_113

**Price:**

**Stock:** instock

**Categories:** [Electronics](#), [General science](#), [Physics](#), [Projects](#), [School Project & Experiment](#)

## Product Description

---



## Storage Cap Electrolytic

### Kit Includes:

- **Project Kit**
- **9V Battery**
- **Print Short R**

### Available offers:

- **Free Shipping**  
orders above F
- **Pay with UPI**  
Discount./[Coup](#)
- **Special Bulk**  
Companies an
- **Get Special D**  
WhatsApp@91

### Highlights Brand

- No Brand Nam  
PCB & Projects



- 100% Working project
- Tested Project & Activity kits

### Documentation

- Printed Short Report
- Printable Soft copy of Project Report

### Support

- Demo Video – **Embedded below**
- Technical Support – WhatsApp@9109087333
- [Get Discount Coupon](#)

[Read More](#)

**SKU:** PH\_SPE\_114

**Price:**

**Stock:** instock

**Categories:** [Electronics](#), [General science](#), [Physics](#), [Projects](#), [School Project & Experiment](#)

## Product Description

---

## Structure o

### Kit Includes:

- **Project Kit**
- **9V Battery**
- **Print Short R**

### Available offers:

- **Free Shipping**  
orders above F
- **Pay with UPI**  
Discount./[Coup](#)



- **Special Bulk Discounts** – for colleges, Schools, Companies and resellers. /[Contact Us](#).
- **Get Special Discount Coupon** – WhatsApp@9109087333.

### **Highlights Branding Free Project / Activity kit**

- No Brand Name/Logo/Watermark on Components, PCB & Projects
- 100% Working project
- Tested Project & Activity kits

### **Documentation**

- Printed Short Report
- Printable Soft copy of Project Report

### **Support**

- Demo Video – **Embedded below**
- Technical Support – WhatsApp@9109087333
- [Get Discount Coupon](#)

[Read More](#)

**SKU:** PH\_SPE\_152

**Price:**

**Stock:** instock

**Categories:** [Electronics](#), [General science](#), [Physics](#), [Projects](#), [School Project & Experiment](#)

## **Product Description**

---



## Structure o

### Kit Includes:

- **Project Kit**
- **9V Battery**
- **Print Short R**

### Available offers:

- **Free Shipping**  
orders above F
- **Pay with UPI**  
Discount./[Cou](#)
- **Special Bulk**  
Companies an
- **Get Special D**  
WhatsApp@91

### Highlights Brand

- No Brand Nam
- PCB & Projects
- 100% Working
- Tested Project

### Documentation

- Printed Short F
- Printable Soft

### Support

- Demo Video –
- Technical Supp
- [Get Discount C](#)

[Read More](#)

**SKU:** PH\_SPE\_153

**Price:**

**Stock:** instock

**Categories:** [Electronics](#), [General science](#), [Physics](#), [Projects](#), [School Project & Experiment](#)

## Product Description

---



## Structure o

### Kit Includes:

- **Project Kit**
- **9V Battery**
- **Print Short R**

### Available offers:

- **Free Shipping**  
orders above ₹
- **Pay with UPI**  
Discount./[Cou](#)
- **Special Bulk**  
Companies an
- **Get Special D**  
WhatsApp@91

### Highlights Brand

- No Brand Nam
- PCB & Projects
- 100% Working
- Tested Project

### Documentation

- Printed Short F
- Printable Soft

### Support

- Demo Video –
- Technical Supp

- [Get Discount Coupon](#)

[Read More](#)

**SKU:** PH\_SPE\_151

**Price:**

**Stock:** instock

**Categories:** [Electronics](#), [General science](#), [Physics](#), [Projects](#), [School Project & Experiment](#)

## Product Description

---



## Switching A

### Kit Includes:

- **Project Kit**
- **9V Battery**
- **Print Short R**

### Available offers:

- **Free Shipping**  
orders above ₹
- **Pay with UPI**  
Discount./[Cou](#)
- **Special Bulk**  
Companies an
- **Get Special D**  
WhatsApp@91

### Highlights Brand

- No Brand Nam  
PCB & Projects
- 100% Working
- Tested Project

### Documentation

- Printed Short Report
- Printable Soft copy of Project Report

### Support

- Demo Video – **Embedded below**
- Technical Support – WhatsApp@9109087333
- [Get Discount Coupon](#)

[Read More](#)

**SKU:** PH\_SPE\_118

**Price:**

**Stock:** instock

**Categories:** [Electronics](#), [General science](#), [Physics](#), [Projects](#), [School Project & Experiment](#)

## Product Description

---

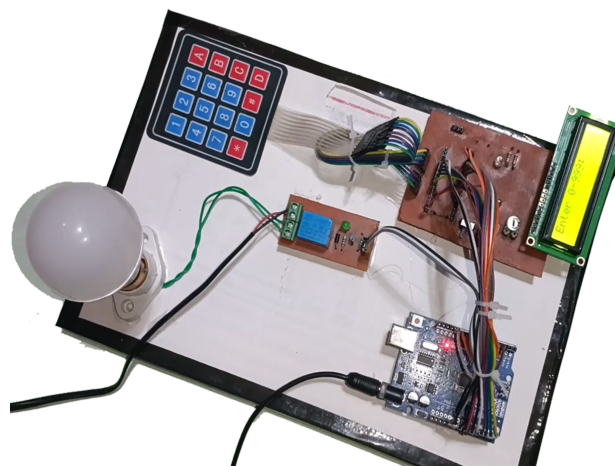

## Testing Life Arduino

### Available offer

- **Free Shipping** above Rs999.
- Pay with UPI QR [Coupons](#)
- **Special Bulk D** Companies and
- Get Special Dis 9109087333.

### Highlights

**Branding Free Pr**

- No Brand Name/Logo/Watermark on Components, PCB & Projects
- 100% Working project
- Tested Project & Activity kits

### Documentation

- Free Project Synopsis – **Embedded below**
- Printed Short Report
- Printable Soft copy of Project Report

### Support

- Demo Video – **Embedded below**
- Technical Support – WhatsApp@9109087333
- [Get Discount Coupon](#)

### Delivery Time

- **Handling Period** : 1-2 Days
- **Transit Time** :3-5 Days (Approx.)
- **Delivery Time** : Handling Period + Transit Time (4-7 Days Approx.)

[Read More](#)

**SKU:** PH\_EP\_141

**Price:** ~~₹5,000.00~~ Original price was: ₹5,000.00.₹  
2,300.00Current price is: ₹2,300.00.

**Stock:** instock

**Categories:** [Arduino](#), [Engineering project](#), [Projects](#)

**Tags:** [Arduino Project](#), [destiny lab](#), [dret](#), [electrical and electronics engineering project](#), [electrical gadget](#), [electrical project](#), [electronic project](#), [engineering project](#), [free project idea](#), [Inspire Award project](#), [new project](#), [Project hub](#), [project hub bharat](#), [school project](#)

## Product Description

---

# Third Eye for Glove

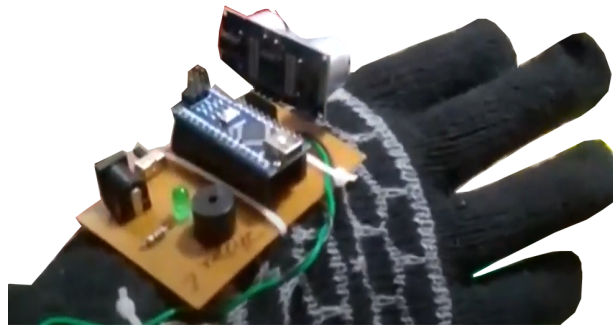

## Available offer

- **Free Shipping** above Rs999.
- Pay with UPI QR [Coupons](#)
- **Special Bulk D** Companies and m
- Get Special Dis 9109087333.

## Highlights

### Branding Free Pr

- No Brand Name/ Projects
- 100% Working p
- Tested Project &

### Documentation

- Free Project Syn
- Printed Short Re
- Printable Soft co

### Support

- Demo Video – **En**
- Technical Suppo
- [Get Discount Co](#)

### Delivery Time

- **Handling Perio**



- **Transit Time** :3-5 Days (Approx.)
- **Delivery Time** : Handling Period + Transit Time (4-7 Days Approx.)

[Click Here to Buy Do It Yourself Kit](#)

[Read More](#)

**SKU:** PH\_EP\_002

**Price:** ~~₹2,464.00~~ Original price was: ₹2,464.00. ₹1,454.00 Current price is: ₹1,454.00.

**Stock:** instock

**Categories:** [Arduino](#), [Engineering project](#), [Exhibition Models & Inspire Award](#), [Projects](#), [Technology & Innovation](#), [Wearable Technology](#)

**Tags:** [Accessibility technology](#), [Arduino coding](#), [Arduino project for students](#), [Arduino tutorial](#), [Assistive technology](#), [Educational projects](#), [Electronics engineering](#), [Engineering students](#), [Exhibition projects](#), [Innovation for the blind](#), [School projects](#), [Sensors and actuators](#), [Third Eye for the Blind](#), [Visually impaired](#)

## Product Description

### Abstract:

According to estimates from the World Health Organization (WHO) Prevention of Blindness and Deafness Program: About **285 million people** are visually impaired worldwide: 39 million are blind and 246 million have low vision. Now a days there are so many instruments and smart devices for visually impaired peoples for navigation but most of them have certain problems for carrying and the major drawbacks is those need a lot of training to use. So the aim of the project is to develop a cheap and more efficient way to help visually impaired to navigate with greater comfort, speed and confidence. **Existing Systems & their**

### problems:

1. Blind sticks- May easily crack/break; the stick may get stuck at pavement cracks of different objects.
2. Smart devices (eg: Vision a torch for blinds)- **Cannot be carried easily**, needs a lot of training to use

**Solution:** To solve this problem we are going to make one of the best wearable technologies based innovative device which will detects nearby objects or obstacles and notify with buzzer & vibrators. This devices is called **“Third Eye for blind with Vibrator Glove”** This technology will resolves all the problems of existing technologies. This device will help the blind to navigate without holding a stick. Simply wear it as a

band or cloth and it can function very accurately and they only need a very little training to use it.

---

[Download Free Project Synopsis](#)

---

[Working Video](#)

---

### Disclaimer:

This is a handmade complete working Models, Projects & Activity kits supported by rough study material to make a suitable projects report by the student. It is using Cardboard/Wooden base, Paper, Foam based board, stationary items, Electronic-Electrical Components, Mechanical & Scientific goods as per the requirement of a particular model. Colour of product and decoration item may be varying according to availability of material but we make ensure that we will deliver the product with same working, structure and dimensions as describe in product description section.

---

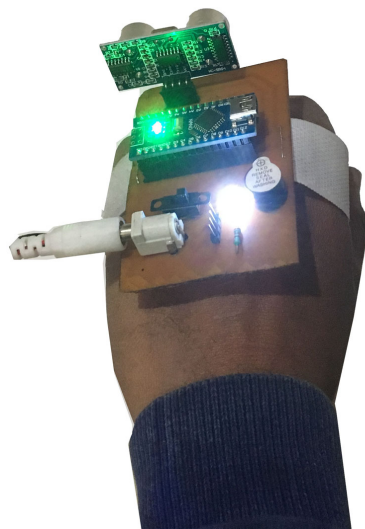

## Third Eye for Arduino

### Available offer

- **Free Shipping** above Rs999.
- Pay with UPI QR [Coupons](#)
- **Special Bulk D** Companies and
- Get Special Dis 9109087333.

### Highlights

#### Branding Free Pr

- No Brand Name/ Projects
- 100% Working p

- Tested Project & Activity kits

## Documentation

- Free Project Synopsis – **Embedded below**
- Printed Short Report
- Printable Soft copy of Project Report

## Support

- Demo Video – **Embedded below**
- Technical Support – WhatsApp@9109087333
- [Get Discount Coupon](#)

## Delivery Time

- **Handling Period** : 1-2 Days
- **Transit Time** :3-5 Days (Approx.)
- **Delivery Time** : Handling Period + Transit Time (4-7 Days Approx.)

[Click Here to Buy Do It Yourself Kit](#)

[Read More](#)

**SKU:** PH\_EP\_001

**Price:** ~~₹2,320.00~~ Original price was: ₹2,320.00.₹  
1,369.00Current price is: ₹1,369.00.

**Stock:** instock

**Categories:** [Arduino](#), [Engineering project](#), [Exhibition Models & Inspire Award](#), [Projects](#), [Technology & Innovation](#), [Wearable Technology](#)

**Tags:** [Arduino IDE download](#), [Arduino programming tutorial](#), [Arduino project for students](#), [Assistive technology for the visually impaired](#), [Audio feedback device](#), [Electrical engineering project](#), [Electronics engineering project](#), [Engineering student projects](#), [Exhibition project](#), [Obstacle detection device](#), [School project ideas](#), [Third Eye for the Blind](#), [Ultrasonic sensors](#), [Wearable technology](#)

## Product Description

### Abstract:

According to estimates from the World Health Organization (WHO) Prevention of Blindness and Deafness Program: About **285 million people** are visually impaired worldwide: 39 million are blind and 246 million have low vision. Now a days there are so many instruments and smart devices for visually impaired peoples for navigation but most of them have certain problems for carrying and the major drawbacks is those need a lot of training to use. So the aim of the project is to develop a cheap and more efficient way to help visually impaired to navigate with greater comfort, speed and confidence.

### Existing Systems & their problems:

1. Blind sticks- May easily crack/break; the stick may get stuck at pavement cracks of different objects.
2. Smart devices (eg: Vision a torch for blinds)- **Cannot be carried easily**, needs a lot of training to use

### Solution:

To solve this problem we are going to make one of the best wearable technologies based innovative device which will detects nearby objects or obstacles and notify with buzzer & vibrators. This devices is called "**THIRD EYE FOR BLIND PERSON**" This technology will resolves all the problems of existing technologies. This device will help the blind to navigate without holding a stick. Simply wear it as a band or cloth and it can function very accurately and they only need a very little training to use it.

---

[Download Free Project Synopsis](#)

---

[Working Video](#)

---

### Disclaimer:

This is a handmade complete working Models, Projects & Activity kits supported by rough study material to make a suitable projects report by the student. It is using Cardboard/Wooden base, Paper, Foam based board, stationary items, Electronic-Electrical Components, Mechanical & Scientific goods as per the requirement of a particular model. Colour of product and decoration

item may be varying according to availability of material but we make ensure that we will deliver the product with same working, structure and dimensions as describe in product description section.

---

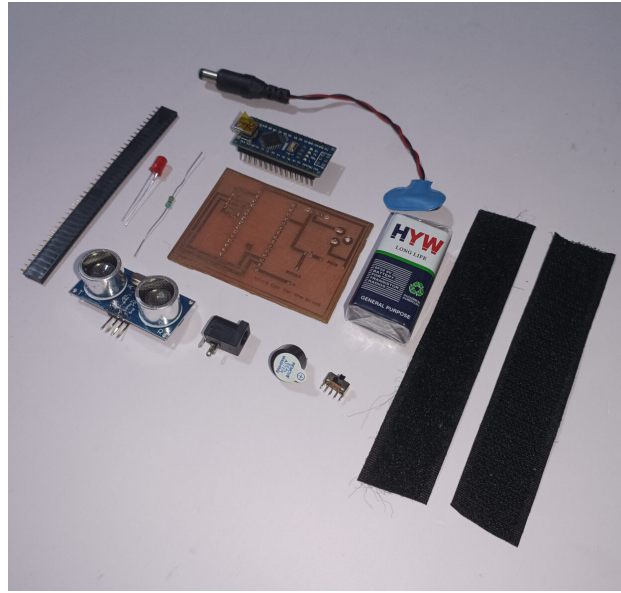

## Third Eye for Arduino-DIY

### Available offer

- **Free Shipping** above Rs999.
- COD available in above 999.
- Pay with UPI QR [Coupons](#)
- **Special Bulk D** Companies and
- Get Special Disc

---

## Highlights

### Branding Free Pr

- No Brand Name/ Projects
- 100% Working p
- Tested Project &

### Documentation

- Free Project Syn
- Printed Short Re
- Printable Soft co

### Support

- Demo Video – **En**

- Technical Support - WhatsApp@9109087333
- [Get Discount Coupon](#)

---

**NOTE:** This Kit Includes Pre-programmed Arduino Board you don't need to upload code until you have to change anything.

**NOTE:** This kit required soldering & circuit testing skills, buy this kit if you have good soldering skills, otherwise you can also buy 'ready to use' project for same topic.

---

[Click Here to Buy Ready to Use Kit.](#)

[Read More](#)

**SKU:** PH\_EPK\_001

**Price:** ~~₹3,000.00~~ Original price was: ₹3,000.00. ₹1,299.00 Current price is: ₹1,299.00.

**Stock:** instock

**Categories:** [Arduino](#), [Engineering project kit \(EPK\)](#), [Hobby DIY kits](#), [WEARABLE TECHNOLOGY](#)

**Tags:** [Arduino IDE download](#), [Arduino programming tutorial](#), [Arduino project for students](#), [Assistive technology for the visually impaired](#), [Audio feedback device](#), [Electrical engineering project](#), [Electronics engineering project](#), [Engineering student projects](#), [Exhibition project](#), [Obstacle detection device](#), [School project ideas](#), [Third Eye for the Blind](#), [Ultrasonic sensors](#), [Wearable technology](#)

## Product Description

### Kit Includes :

- Electronic Parts (listed in product image)
- Circuit Diagram
- Project Code
- Printed Circuit Board (PCB)
- Printed Short Report

### Prerequisite Requirements

## Hardware :

1. [Soldering Iron \(Buy Now \)](#)
2. [Soldering Paste \(Buy Now \)](#)
3. [Soldering Wire \(Buy Now \)](#)
4. [Soldering Stand \(Buy Now\)](#)
5. [Wire Cutter \(Buy Now\)](#)
6. [Screw Driver \(Buy Now\)](#)

## Software :

1. Arduino IDE (optional) - [Download Now](#)

[Demo Video - How to Download Arduino IDE ?](#)

## Skills:

1. Arduino Programming (optional)
2. Soldering ([Click Here for Free Tutorial](#))
3. Circuit Testing

---

## Abstract:

According to estimates from the World Health Organization (WHO) Prevention of Blindness and Deafness Program: About **285 million people** are visually impaired worldwide: 39 million are blind and 246 million have low vision. Now a days there are so many instruments and smart devices for visually impaired peoples for navigation but most of them have certain problems for carrying and the major drawbacks is those need a lot of training to use. So the aim of the project is to develop a cheap and more efficient way to help visually impaired to navigate with greater comfort, speed and confidence.

## Existing Systems & their problems:

1. Blind sticks- May easily crack/break; the stick may get stuck at pavement cracks of different objects.
2. Smart devices (eg: Vision a torch for blinds)- **Cannot be carried easily**, needs a lot of training to use

## Solution:

To solve this problem we are going to make one of the best wearable technologies based

innovative device which will detects nearby objects or obstacles and notify with buzzer & vibrators. This devices is called “**THIRD EYE FOR BLIND PERSON**” This technology will resolves all the problems of existing technologies. This device will help the blind to navigate without holding a stick. Simply wear it as a band or cloth and it can function very accurately and they only need a very little training to use it.

---

[Download Free Project Synopsis](#)

---

[Working Video](#)

---

### Disclaimer:

This is a handmade complete working Models, Projects & Activity kits supported by rough study material to make a suitable projects report by the student. It is using Cardboard/Wooden base, Paper, Foam based board, stationary items, Electronic-Electrical Components, Mechanical & Scientific goods as per the requirement of a particular model. Colour of product and decoration item may be varying according to availability of material but we make ensure that we will deliver the product with same working, structure and dimensions as describe in product description section.

---



## Third Eye for Bundle

### Support

- Demo Video – [En](#)
- Technical Support
- [Get Discount Co](#)

---

[Click Here to Buy](#)  
[Buy Do It Yourself](#)  
[Read More](#)

**SKU:** PH\_DG\_009

**Price:** ₹500.00 Orig  
Current price is: ₹4



**Stock:** instock

**Categories:** [Digital Products](#), [Project Codes](#)

## Product Description

### Bundle Includes :

1. Synopsis
2. Circuit Diagram
3. Project Code
4. Printed Circuit Board - PCB
5. Printed Short Report

### Prerequisite Requirements

#### Hardware :

1. [Soldering Iron \(Buy Now \)](#)
2. [Soldering Paste \(Buy Now \)](#)
3. [Soldering Wire \(Buy Now \)](#)
4. [Soldering Stand \(Buy Now\)](#)
5. [Wire Cutter \(Buy Now\)](#)
6. [Screw Driver \(Buy Now\)](#)
7. Electronic Parts
  - o [Arduino Nano \(Buy Now\)-1](#)
  - o [Ultrasonic Module \(Buy Now\)- 1](#)
  - o [Buzzer \(Buy Now\) - 1](#)
  - o [Slide Switch \(Buy Now\)- 1](#)
  - o [DC Socket \(Buy Now\)- 1](#)
  - o [DC Pin \(Buy Now\)- 1](#)
  - o [Resistor – 470 Ohm \(Buy Now\)-1](#)
  - o [LED \(Buy Now\)- 1](#)
  - o Printed Circuit Board - 1
  - o [DC Battery 9V \(Buy Now\) - 1](#)
  - o [Female Header \(Buy Now\)- 1](#)

#### Software :

1. Arduino IDE - [Download Now](#)

## [Demo Video - How to Download Arduino IDE ?](#)

### **Skills:**

1. PCB printing at Home
  2. Soldering ([Click Here for Free Tutorial](#))
  3. Arduino Programming (optional)
  4. Program uploading in Arduino
  5. Circuit Testing
- 

- **DO NOT CHANGE ANYTHING IN THE PROGRAM. ARDUINO CODES ARE CASE SENSITIVE, ON CHANGING OF SINGAL WORD CAN OCCUR COMPILING ERROR.**
  - **COPY & PASTE PROGRAM INTO ARDUINO IDE**
  - **DOWNLOAD ARDUINO IDE FROM <https://www.arduino.cc/en/software>.**
- 

### **Abstract:**

According to estimates from the World Health Organization (WHO) Prevention of Blindness and Deafness Program: About **285 million people** are visually impaired worldwide: 39 million are blind and 246 million have low vision. Now a days there are so many instruments and smart devices for visually impaired peoples for navigation but most of them have certain problems for carrying and the major drawbacks is those need a lot of training to use. So the aim of the project is to develop a cheap and more efficient way to help visually impaired to navigate with greater comfort, speed and confidence.

### **Existing Systems & their problems:**

1. Blind sticks- May easily crack/break; the stick may get stuck at pavement cracks of different objects.
2. Smart devices (eg: Vision a torch for blinds)- **Cannot be carried easily**, needs a lot of training to use

### **Solution:**

To solve this problem we are going to make one of the best wearable technologies based innovative device which will detects nearby objects or obstacles and notify with buzzer & vibrators. This devices is called "**THIRD EYE FOR BLIND PERSON**" This technology will resolves all the problems of existing technologies. This device will help the blind to navigate without holding a stick. Simply wear it as a band or cloth and it can function very accurately and they only need a very little training to use it.

---

## [Download Free Project Synopsis](#)

---

### **Working Video:**

---



**To assemble  
comprising  
(on/off) swi  
power sour**

#### **Kit Includes:**

- **Project Kit**
- **9V Battery**
- **Print Short R**

#### **Available offers:**

- **Free Shipping**  
orders above F
- **Pay with UPI**  
Discount./[Cou](#)
- **Special Bulk**  
Companies an
- **Get Special D**  
WhatsApp@91

#### **Highlights Brand**

- No Brand Nam  
PCB & Projects
- 100% Working
- Tested Project

#### **Documentation**

- Printed Short F

- Printable Soft copy of Project Report

### Support

- Demo Video – **Embedded below**
- Technical Support – WhatsApp@9109087333
- [Get Discount Coupon](#)

[Read More](#)

**SKU:** PH\_SPE\_60

**Price:**

**Stock:** instock

**Categories:** [Electronics](#), [General science](#), [Physics](#), [Projects](#), [School Project & Experiment](#)

## Product Description

---



## To Measure Current and Continuity of using a Mul

### Kit Includes:

- **Project Kit**
- **9V Battery**
- **Print Short R**

### Available offers:

- **Free Shipping**  
orders above ₹
- **Pay with UPI**  
Discount./[Cou](#)
- **Special Bulk**  
Companies an

- **Get Special Discount Coupon** –  
WhatsApp@9109087333.

### **Highlights Branding Free Project / Activity kit**

- No Brand Name/Logo/Watermark on Components, PCB & Projects
- 100% Working project
- Tested Project & Activity kits

### **Documentation**

- Printed Short Report
- Printable Soft copy of Project Report

### **Support**

- Demo Video – **Embedded below**
- Technical Support – WhatsApp@9109087333
- [Get Discount Coupon](#)

[Read More](#)

**SKU:** PH\_SPE\_63

**Price:** ~~₹988.00~~ Original price was: ₹988.00. ₹583.00  
Current price is: ₹583.00.

**Stock:** instock

**Categories:** [Electronics](#), [General science](#), [Physics](#), [Projects](#), [School Project & Experiment](#)

## **Product Description**

---

# To Study Effect of Intensity of Light On an LDR

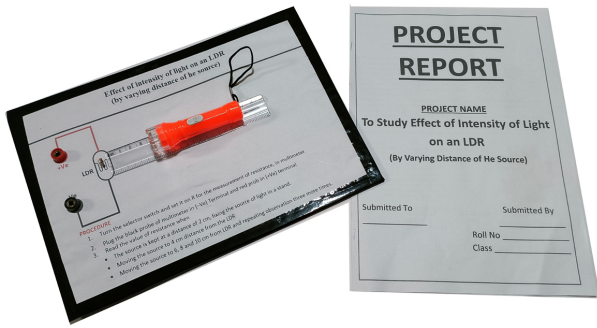

## Package Includes:

## Branding Free Activity kit

- No Brand Name/Logo/Watermark on Components, PCB & Projects
- Tested Activity kits

## Documentation

- Free Project Synopsis – **Embedded below**
- Printed instruction booklet

## Support

- Working Video – **Embedded Below**
- Technical Support – WhatsApp@9109087333
- Get Discount Coupon - WhatsApp@9303254433

[Read More](#)

**SKU:** PH\_SPE\_40

**Price:** ~~₹332.00~~ Original price was: ₹332.00. ₹196.00  
Current price is: ₹196.00.

**Stock:** instock

**Categories:** [Electronics](#), [Physics](#), [Projects](#), [School Project & Experiment](#)

**Tags:** [class 12th science project and experiment](#), [new science project](#)

## Product Description

## Download Free Project Synopsis

## Disclaimer

This is a handmade complete working Models, Projects & Activity kits supported by rough study material to make a suitable projects report by the student. It is using Cardboard/Wooden base, Paper, Foam based board, stationary items, Electronic-Electrical Components, Mechanical & Scientific goods as per the requirement of a particular model. Colour of product and decoration item may be varying according to availability of material but we make ensure that we will deliver the product with same working, structure and dimensions as describe in product description section.

---

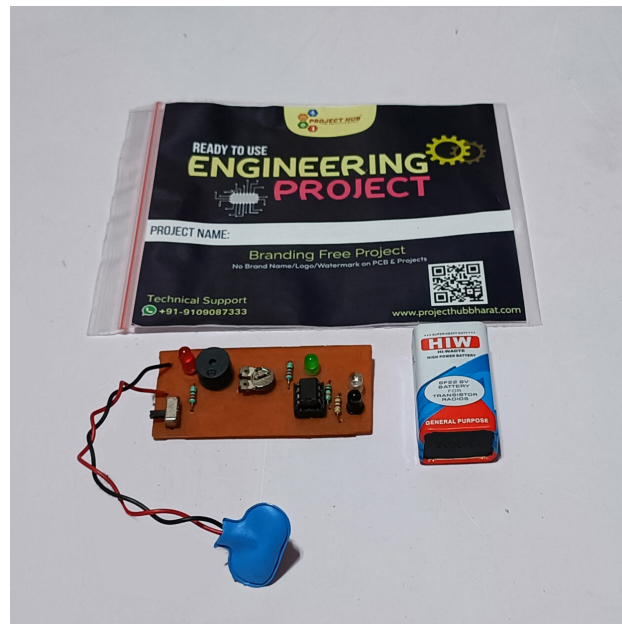

## Touch less & Handmade

### Available offer

- **Free Shipping** above Rs999.
- COD available in above 999.
- Pay with UPI QR [Coupons](#)
- **Special Bulk D** Companies and
- Get Special Disc

## Highlights

### Branding Free Pr

- No Brand Name/ Projects
- 100% Working p
- Tested Project &

## Documentation

- Free Project Synopsis - **Embedded below**
- Printed Short Report
- Printable Soft copy of Project Report

### Support

- Demo Video - **Embedded below**
- Technical Support - WhatsApp@9109087333
- [Get Discount Coupon](#)

[Click Here to Buy Do It Yourself Kit](#)

[Read More](#)

**SKU:** PH\_EP\_023

**Price:** ~~₹416.00~~ Original price was: ₹416.00. ₹245.00

Current price is: ₹245.00.

**Stock:** instock

**Categories:** [Engineering project](#), [IC & Transistor](#), [Mini Project](#), [Projects](#)

## Product Description

### INTRODUCTION:

We all have a doorbell at our homes. When a guest comes to our house, they search for the doorbell switch and then ring it to let us know their presence. If who came to our house and unable to find doorbell, else person is so short then they cannot find the doorbell in this case we need a solution that can find the presence of a person and rings the doorbell automatically. Here we are making an object sensing based “**Touch Less Doorbell**” using infrared transceiver pair and some locally available components. It can detect the presence of a person and then if the person is detected, the doorbell is automatically turned ON when the person is in-front of the door. The touchless doorbell project is designed to provide a contactless alternative for ringing doorbells, eliminating the need for physical buttons or switches. This project employs the LM358 IC, an IR receiver and transmitter pair, and a 10k preset. By utilizing infrared technology, the system detects hand gestures and triggers the doorbell, enhancing convenience and hygiene.

### AIM:



The aim of this project is to develop a touchless doorbell system that enables users to ring the doorbell without physical contact. By using hand gestures to activate the doorbell, this project promotes cleanliness, especially in public spaces where multiple people may use the doorbell.

**PRINCIPLE:**

The touchless doorbell project operates on the principle of infrared sensing. Infrared light is emitted by the IR transmitter and detected by the IR receiver. When an object, such as a hand, interrupts the infrared beam between the transmitter and receiver, the system recognizes the gesture and activates the doorbell.

---

**[Download Free Project Synopsis](#)**

**Working Video**

---

**Disclaimer:**

This is a handmade complete working Models, Projects & Activity kits supported by rough study material to make a suitable projects report by the student. It is using Cardboard/Wooden base, Paper, Foam based board, stationary items, Electronic-Electrical Components, Mechanical & Scientific goods as per the requirement of a particular model. Colour of product and decoration item may be varying according to availability of material but we make ensure that we will deliver the product with same working, structure and dimensions as describe in product description section.

---

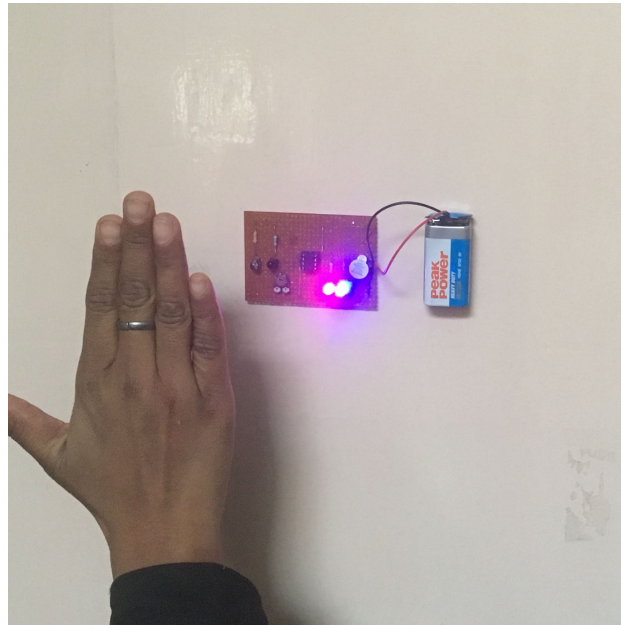

## Touch less Sensor

### Available offer

- **Free Shipping** above Rs999.
- COD available in above 999.
- Pay with UPI QR [Coupons](#)
- **Special Bulk D** Companies and
- Get Special Disc

### Highlights

#### Branding Free Pr

- No Brand Name/ Projects
- 100% Working p
- Tested Project &

#### Documentation

- Free Project Syn
- Printed Short Re
- Printable Soft co

#### Support

- Demo Video – **En**
- Technical Suppo
- [Get Discount Co](#)

[Click Here to Buy D](#)  
[Read More](#)

**SKU:** PH\_EP\_090

**Price:** ₹400.00 Original price was: ₹400.00. ~~₹236.00~~  
Current price is: ₹236.00.

**Stock:** instock

**Categories:** [Engineering project](#), [Exhibition Models & Inspire Award](#), [IC & Transistor](#), [Mini Project](#), [Projects](#), [Security](#), [Technology & Innovation](#)

**Tags:** [Arduino Project](#), [Contactless Doorbell](#), [DIY electronics](#), [Home Automation](#), [Home Security](#), [Infrared Motion Detection](#), [Internet of Things \(IoT\)](#), [Sensor Technology](#), [Smart Home Project](#), [Touch-Free Doorbell](#), [Touchless Doorbell](#), [Wireless Doorbell](#)

## Product Description

### Introduction:

We all have a doorbell at our homes. When a guest comes to our house, they search for the doorbell switch and then ring it to let us know their presence. If who came to our house and unable to find doorbell, else person is so short then they cannot find the doorbell in this case we need a solution that can find the presence of a person and rings the doorbell automatically. Here we are making an object sensing based “**Touch Less Doorbell**” using infrared transceiver pair and some locally available components. It can detect the presence of a person and then if the person is detected, the doorbell is automatically turned ON when the person is in-front of the door. The touchless doorbell project is designed to provide a contactless alternative for ringing doorbells, eliminating the need for physical buttons or switches. This project employs the LM358 IC, an IR receiver and transmitter pair, and a 10k preset. By utilizing infrared technology, the system detects hand gestures and triggers the doorbell, enhancing convenience and hygiene.

### Aim:

The aim of this project is to develop a touchless doorbell system that enables users to ring the doorbell without physical contact. By using hand gestures to activate the doorbell, this project promotes cleanliness, especially in public spaces where multiple people may use the doorbell.

### Principle:

The touchless doorbell project operates on the principle of infrared sensing. Infrared light is

emitted by the IR transmitter and detected by the IR receiver. When an object, such as a hand, interrupts the infrared beam between the transmitter and receiver, the system recognizes the gesture and activates the doorbell.

---

[\*\*Download Free Project Synopsis\*\*](#)

---

[\*\*Working Video\*\*](#)

---

**Disclaimer:**

This is a handmade complete working Models, Projects & Activity kits supported by rough study material to make a suitable projects report by the student. It is using Cardboard/Wooden base, Paper, Foam based board, stationary items, Electronic-Electrical Components, Mechanical & Scientific goods as per the requirement of a particular model. Colour of product and decoration item may be varying according to availability of material but we make ensure that we will deliver the product with same working, structure and dimensions as describe in product description section.

---

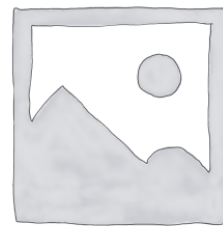

## Touch less Sensor- DIY

### Available offer

- **Free Shipping** above Rs999.
- COD available in above 999.
- Pay with UPI QR [Coupons](#)
- **Special Bulk D** Companies and
- Get Special Disc

### Highlights

### Branding Free Pr

- No Brand Name/Logo/Watermark on Components, PCB & Projects
- 100% Working project
- Tested Project & Activity kits

### Documentation

- Free Project Synopsis – **Embedded below**
- Printed Short Report
- Printable Soft copy of Project Report

### Support

- Demo Video – **Embedded below**
- Technical Support – WhatsApp@9109087333
- [Get Discount Coupon](#)

[Click Here to Buy Ready to Use Kit](#)

[Read More](#)

**SKU:** PH\_EPK\_090

**Price:** ₹400.00 Original price was: ₹400.00. ~~₹350.00~~  
Current price is: ₹350.00.

**Stock:** instock

**Categories:** [Hobby DIY kits](#), [IC & TRANSISTOR](#)

**Tags:** [Arduino Project](#), [Contactless Doorbell](#), [DIY electronics](#), [Home Automation](#), [Home Security](#), [Infrared Motion Detection](#), [Internet of Things \(IoT\)](#), [Sensor Technology](#), [Smart Home Project](#), [Touch-Free Doorbell](#), [Touchless Doorbell](#), [Wireless Doorbell](#)

## Product Description

### Kit Includes :

- Electronic Parts (listed in product image)
- Circuit Diagram
- Printed Circuit Board (PCB)
- Printed Short Report

## Prerequisite Requirements

### Hardware :

1. [Soldering Iron \(Buy Now \)](#)
2. [Soldering Paste \(Buy Now \)](#)
3. [Soldering Wire \(Buy Now \)](#)
4. [Soldering Stand \(Buy Now\)](#)
5. [Wire Cutter \(Buy Now\)](#)
6. [Screw Driver \(Buy Now\)](#)

### Skills:

1. Soldering ([Click Here for Free Tutorial](#))
  2. Circuit Testing
- 

## Introduction:

We all have a doorbell at our homes. When a guest comes to our house, they search for the doorbell switch and then ring it to let us know their presence. If who came to our house and unable to find doorbell, else person is so short then they cannot find the doorbell in this case we need a solution that can find the presence of a person and rings the doorbell automatically. Here we are making an object sensing based “**Touch Less Doorbell**” using infrared transceiver pair and some locally available components. It can detect the presence of a person and then if the person is detected, the doorbell is automatically turned ON when the person is in-front of the door. The touchless doorbell project is designed to provide a contactless alternative for ringing doorbells, eliminating the need for physical buttons or switches. This project employs the LM358 IC, an IR receiver and transmitter pair, and a 10k preset. By utilizing infrared technology, the system detects hand gestures and triggers the doorbell, enhancing convenience and hygiene.

### Aim:

The aim of this project is to develop a touchless doorbell system that enables users to ring the doorbell without physical contact. By using hand gestures to activate the doorbell, this project promotes cleanliness, especially in public spaces where multiple people may use the doorbell.

### Principle:

The touchless doorbell project operates on the principle of infrared sensing. Infrared light is

emitted by the IR transmitter and detected by the IR receiver. When an object, such as a hand, interrupts the infrared beam between the transmitter and receiver, the system recognizes the gesture and activates the doorbell.

---

[\*\*Download Free Project Synopsis\*\*](#)

---

[\*\*Working Video\*\*](#)

---

**Disclaimer:**

This is a handmade complete working Models, Projects & Activity kits supported by rough study material to make a suitable projects report by the student. It is using Cardboard/Wooden base, Paper, Foam based board, stationary items, Electronic-Electrical Components, Mechanical & Scientific goods as per the requirement of a particular model. Colour of product and decoration item may be varying according to availability of material but we make ensure that we will deliver the product with same working, structure and dimensions as describe in product description section.

---

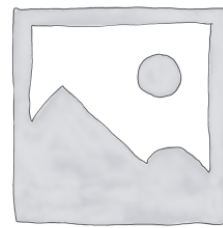

## Transforma energy to m (Motor & wh

**Kit Includes:**

- **Project Kit**
- **9V Battery**
- **Print Short R**

**Available offers:**

- **Free Shipping**  
orders above F
- **Pay with UPI**  
Discount./[Coup](#)
- **Special Bulk**  
Companies an

- **Get Special Discount Coupon** –  
WhatsApp@9109087333.

### **Highlights Branding Free Project / Activity kit**

- No Brand Name/Logo/Watermark on Components, PCB & Projects
- 100% Working project
- Tested Project & Activity kits

### **Documentation**

- Printed Short Report
- Printable Soft copy of Project Report

### **Support**

- Demo Video – **Embedded below**
- Technical Support – WhatsApp@9109087333
- [Get Discount Coupon](#)

[Read More](#)

**SKU:** PH\_SPE\_119

**Price:**

**Stock:** instock

**Categories:** [Electronics](#), [General science](#), [Physics](#), [Projects](#), [School Project & Experiment](#)

## **Product Description**

---





## Transforma energy to e & wheel)

### Kit Includes:

- **Project Kit**
- **9V Battery**
- **Print Short R**

### Available offers:

- **Free Shipping**  
orders above ₹
- **Pay with UPI**  
Discount./[Cou](#)
- **Special Bulk**  
Companies an
- **Get Special D**  
WhatsApp@91

### Highlights Brand

- No Brand Nam  
PCB & Projects
- 100% Working
- Tested Project

### Documentation

- Printed Short P
- Printable Soft

### Support

- Demo Video –
- Technical Supp
- [Get Discount C](#)

[Read More](#)

**SKU:** PH\_SPE\_120

**Price:**

**Stock:** instock

**Categories:** [Electronics](#), [General science](#), [Physics](#), [Projects](#), [School Project & Experiment](#)

## Product Description

---