

Solar Light DIY Project kit Working Model DIY Science Experiment Kit

Package Includes:

Branding Free Project / Activity kit

- No Brand Name/Logo/Watermark on Components, PCB & Projects
- 100% Working project
- Tested Project & Activity kits

Documentation

- Free Project Synopsis – ***Embedded below***
- Printed instruction booklet

Support

- Working Video – ***Embedded Below***
- Technical Support – WhatsApp@9109087333
- Get Discount Coupon – WhatsApp@9303254433

[Read More](#)

SKU: PH_SPK_051

Price: ~~₹600.00~~ Original price was: ₹600.00. ₹499.00
Current price is: ₹499.00.

Stock: instock

Categories: [ELECTRICITY & MAGNETISM](#),
[ELECTRONICS](#), [Hobby DIY kits](#), [Science Project kit \(SPK\)](#)
, [SOLAR](#)

Product Description

Download Free Project Synopsis

Working Video

This is a handmade complete working Models, Projects & Activity kits supported by rough study material to make a suitable projects report by the student. It is using Cardboard/Wooden base, Paper, Foam based board, stationary items, Electronic-Electrical Components, Mechanical & Scientific goods as per the requirement of a particular model. Colour of product and decoration item may be varying according to availability of material but we make ensure that we will deliver the product with same working, structure and dimensions as describe in product description section.

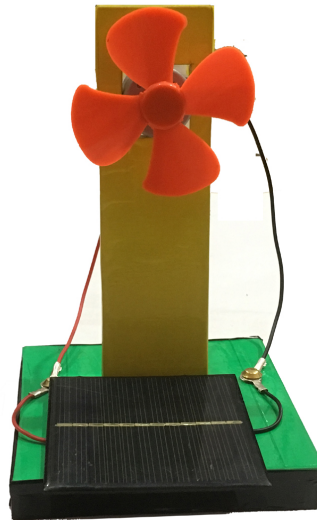

Solar Power Working Sci Energy Con

Package Inc

Branding Free

- No Brand Name
- PCB & Projects
- 100% Working
- Tested Project

Documentation

- Free Project Sy
- Printed instruc

Support

- Working Video
- Technical Supp
- Get Discount C

[Read More](#)

SKU: PH_SPK_050

Price: ₹600.00 Original price was: ₹600.00. ~~₹499.00~~
Current price is: ₹499.00.

Stock: instock

Categories: [Hobby DIY kits](#), [Science Project kit \(SPK\)](#)

Product Description

Download Free Project Synopsis

Working Video

This is a handmade complete working Models, Projects & Activity kits supported by rough study material to make a suitable projects report by the student. It is using Cardboard/Wooden base, Paper, Foam based board, stationary items, Electronic-Electrical Components, Mechanical & Scientific goods as per the requirement of a particular model. Colour of product and decoration item may be varying according to availability of material but we make ensure that we will deliver the product with same working, structure and dimensions as describe in product description section.



Solar Power

Available offer

- **Free Shipping** above Rs999.
- Pay with UPI QR [Coupons](#)
- **Special Bulk D** Companies and
- Get Special Disc

Highlights

Branding Free Pr

- No Brand Name/Logo/Watermark on Components, PCB & Projects
- 100% Working project
- Tested Project & Activity kits

Documentation

- Free Project Synopsis – **Embedded below**
- Printed Short Report
- Printable Soft copy of Project Report (10-15 Page)

Support

- Demo Video – **Embedded below**
- Technical Support – WhatsApp@9109087333
- [Get Discount Coupon](#)

Click Here to Buy Do It Yourself Kit Click Here to Buy Digital Bundle Click Here to Buy Full Project Report

- Printable Soft copy of Project Report (30 -35 Pages)
- Printable Soft copy of Project Report (60 -70 Pages)

[Read More](#)

SKU: PH_EP_038

Price: ~~₹3,196.00~~ Original price was: ₹3,196.00.₹
1,886.00Current price is: ₹1,886.00.

Stock: instock

Categories: [Engineering project](#), [IC & Transistor](#),
[Projects](#), [Solar](#)

Product Description

Disclaimer:

This is a handmade complete working Models, Projects & Activity kits supported by rough study material to make a suitable projects report by the student. It is using Cardboard/Wooden base,

Paper, Foam based board, stationary items, Electronic-Electrical Components, Mechanical & Scientific goods as per the requirement of a particular model. Colour of product and decoration item may be varying according to availability of material but we make ensure that we will deliver the product with same working, structure and dimensions as describe in product description section.

Solder Wire - 10gm (Good Quality)



[Read More](#)

SKU: PH_TI_010

Price: ~~₹50.00~~ Original price was: ₹50.00. ₹20.00
Current price is: ₹20.00.

Stock: instock

Categories: [Electronic Lab](#), [Tools & Laboratory Instruments](#)

Product Description

Solder Wire 10gm is useful if you want to join components and wires, over your PCB. Complete your circuit and join electrically your components through this solder or soldering wire. Solder is a fusible metal alloy used to join together metal workpieces and having a melting point below that of the workpiece(s). Soft solder is typically thought of when solder or soldering is mentioned, with a typical melting range of 90 to 450 °C . It is commonly used in electronics, plumbing, and assembly of sheet metal parts. Manual soldering uses a soldering iron or soldering gun. Alloys that melt between 180 and 190 °C (360 and 370 °F) are the most commonly used. Soldering performed using alloys with a melting point above 450 °C (840 °F) is called brazing.

Features and Specifications:

- Good solderability both in electrical conductivity and thermal conductivity.
- High activity flux makes more reliable soldering and leaves bright shiny solder joints after reflow.
- With the solder wire reel, soldering can be accomplished quickly.
- Widely applied in electrical repairs.
- Net Weight: 10g

Soldering Iron Stand

[Read More](#)

SKU: PH_TI_007

Price: ₹100.00 Original price was: ₹100.00. ~~₹70.00~~
Current price is: ₹70.00.

Stock: instock

Categories: [Electronic Lab](#), [Tools & Laboratory Instruments](#)



Product Description

This is a stable well supported metal base low cost soldering iron stand. It can hold, most of the pen-type soldering iron with its spring holder. A sponge for cleaning the iron comes attached to the base.

Features:

- Ideal for both hobbyists and professional users
 - Suitable for use with most soldering irons
 - Includes a sponge tray for cleaning the soldering iron tip
 - Double spiral spring construction makes it virtually impossible to accidentally touch the iron when inserted into the stand
 - Good and Stable quality
 - Excellent after-sold service
 - Safety
-

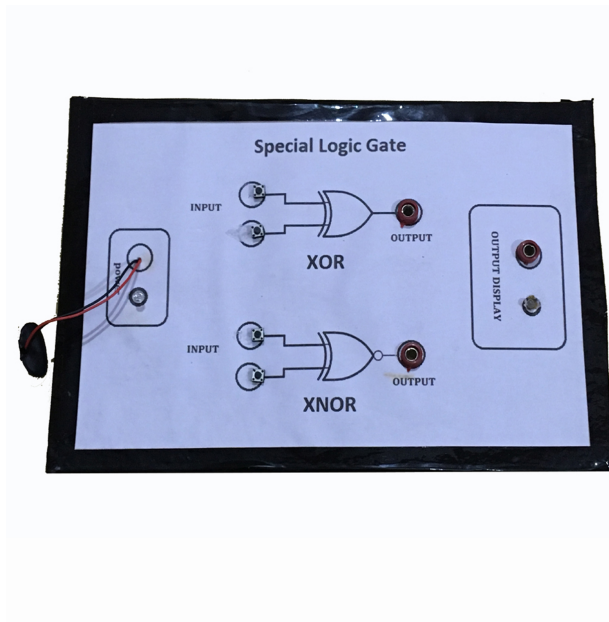

Special Log

Kit Includes:

- Project Kit
- 9V Battery
- Print Short R

Available offers:

- Free Shipping on orders above ₹500
- Pay with UPI for 5% Discount./[Coupon](#)
- Special Bulk Discounts for Companies and Institutions
- Get Special Discount on WhatsApp@919999999999

Highlights Brand

- No Brand Name PCB & Projects
- 100% Working
- Tested Project

Documentation

- Printed Short F
- Printable Soft

Support

- Demo Video –
- Technical Support
- [Get Discount C](#)

[Read More](#)

SKU: PH_SPE_111

Price: ₹600.00 Original Price
Current price is: ₹5

Stock: instock

Categories: [Electronics](#), [Logic Gate](#), [Physics](#), [Projects](#), [School Project & Experiment](#)

Tags: [class 12th science project and experiment](#), [logic gate](#), [new science project](#)

Product Description

Download Free Project Synopsis

Disclaimer

This is a handmade complete working Models, Projects & Activity kits supported by rough study material to make a suitable projects report by the student. It is using Cardboard/Wooden base, Paper, Foam based board, stationary items, Electronic-Electrical Components, Mechanical & Scientific goods as per the requirement of a particular model. Colour of product and decoration item may be varying according to availability of material but we make ensure that we will deliver the product with same working, structure and dimensions as describe in product description section.



Step Down Made)

Kit Includes:

- **Project Kit**
- **9V Battery**
- **Print Short R**

Available offers:

- **Free Shipping**
orders above P
- **Pay with UPI**
Discount./[Coup](#)
- **Special Bulk**
Companies an

- **Get Special Discount Coupon** –
WhatsApp@9109087333.

Highlights Branding Free Project / Activity kit

- No Brand Name/Logo/Watermark on Components, PCB & Projects
- 100% Working project
- Tested Project & Activity kits

Documentation

- Printed Short Report
- Printable Soft copy of Project Report

Support

- Demo Video – **Embedded below**
- Technical Support – WhatsApp@9109087333
- [Get Discount Coupon](#)

[Read More](#)

SKU: PH_SPE_112

Price:

Stock: instock

Categories: [Electronics](#), [General science](#), [Physics](#), [Projects](#), [School Project & Experiment](#)

Product Description



Step Down Experiment

Kit Includes:

- **Project Kit**
- **9V Battery**
- **Print Short R**

Available offers:

- **Free Shipping**
orders above ₹
- **Pay with UPI**
Discount./[Cou](#)
- **Special Bulk**
Companies an
- **Get Special D**
WhatsApp@91

Highlights Brand

- No Brand Name
PCB & Projects
- 100% Working
- Tested Project

Documentation

- Printed Short F
- Printable Soft

Support

- Demo Video –
- Technical Supp
- [Get Discount C](#)

[Read More](#)

SKU: PH_SPE_113

Price:

Stock: instock

Categories: [Electronics](#), [General science](#), [Physics](#), [Projects](#), [School Project & Experiment](#)

Product Description



Storage Cap Electrolytic

Kit Includes:

- **Project Kit**
- **9V Battery**
- **Print Short R**

Available offers:

- **Free Shipping**
orders above ₹
- **Pay with UPI**
Discount./[Coup](#)
- **Special Bulk**
Companies an
- **Get Special D**
WhatsApp@91

Highlights Brand

- No Brand Nam
PCB & Projects
- 100% Working
- Tested Project

Documentation

- Printed Short F
- Printable Soft

Support

- Demo Video – **Embedded below**
- Technical Support – WhatsApp@9109087333
- [Get Discount Coupon](#)

[Read More](#)

SKU: PH_SPE_114

Price:

Stock: instock

Categories: [Electronics](#), [General science](#), [Physics](#), [Projects](#), [School Project & Experiment](#)

Product Description



Structure o

Kit Includes:

- **Project Kit**
- **9V Battery**
- **Print Short R**

Available offers:

- **Free Shipping**
orders above F
- **Pay with UPI**
Discount./[Coup](#)
- **Special Bulk**
Companies an
- **Get Special D**
WhatsApp@91

Highlights Brand

- No Brand Nam
- PCB & Projects
- 100% Working
- Tested Project

Documentation

- Printed Short Report
- Printable Soft copy of Project Report

Support

- Demo Video – **Embedded below**
- Technical Support – WhatsApp@9109087333
- [Get Discount Coupon](#)

[Read More](#)

SKU: PH_SPE_152

Price:

Stock: instock

Categories: [Electronics](#), [General science](#), [Physics](#), [Projects](#), [School Project & Experiment](#)

Product Description



Structure o

Kit Includes:

- **Project Kit**
- **9V Battery**
- **Print Short R**

Available offers:

- **Free Shipping** on orders above ₹
- **Pay with UPI** and get 5% Discount./[Cou](#)
- **Special Bulk** prices for Companies and
- **Get Special D**iscount on WhatsApp@91

Highlights Branding Free Project / Activity kit

- No Brand Name/Logo/Watermark on Components, PCB & Projects
- 100% Working project
- Tested Project & Activity kits

Documentation

- Printed Short Report
- Printable Soft copy of Project Report

Support

- Demo Video – **Embedded below**
- Technical Support – WhatsApp@9109087333
- [Get Discount Coupon](#)

[Read More](#)

SKU: PH_SPE_153

Price:

Stock: instock

Categories: [Electronics](#), [General science](#), [Physics](#), [Projects](#), [School Project & Experiment](#)

Product Description

Structure o

Kit Includes:

- **Project Kit**
- **9V Battery**
- **Print Short R**

Available offers:

- **Free Shippin**
orders above F



- **Pay with UPI QR Code & Get 5% Special Discount.**[/Coupons](#)
- **Special Bulk Discounts** - for colleges, Schools, Companies and resellers. [/Contact Us](#).
- **Get Special Discount Coupon** - WhatsApp@9109087333.

Highlights Branding Free Project / Activity kit

- No Brand Name/Logo/Watermark on Components, PCB & Projects
- 100% Working project
- Tested Project & Activity kits

Documentation

- Printed Short Report
- Printable Soft copy of Project Report

Support

- Demo Video - **Embedded below**
- Technical Support - WhatsApp@9109087333
- [Get Discount Coupon](#)

[Read More](#)

SKU: PH_SPE_151

Price:

Stock: instock

Categories: [Electronics](#), [General science](#), [Physics](#), [Projects](#), [School Project & Experiment](#)

Product Description



Switching A

Kit Includes:

- **Project Kit**
- **9V Battery**
- **Print Short R**

Available offers:

- **Free Shipping**
orders above F
- **Pay with UPI**
Discount./[Coup](#)
- **Special Bulk**
Companies an
- **Get Special D**
WhatsApp@91

Highlights Brand

- No Brand Nam
- PCB & Projects
- 100% Working
- Tested Project

Documentation

- Printed Short F
- Printable Soft

Support

- Demo Video –
- Technical Supp
- [Get Discount C](#)

[Read More](#)

SKU: PH_SPE_118

Price:

Stock: instock

Categories: [Electronics](#), [General science](#), [Physics](#), [Projects](#), [School Project & Experiment](#)

Product Description

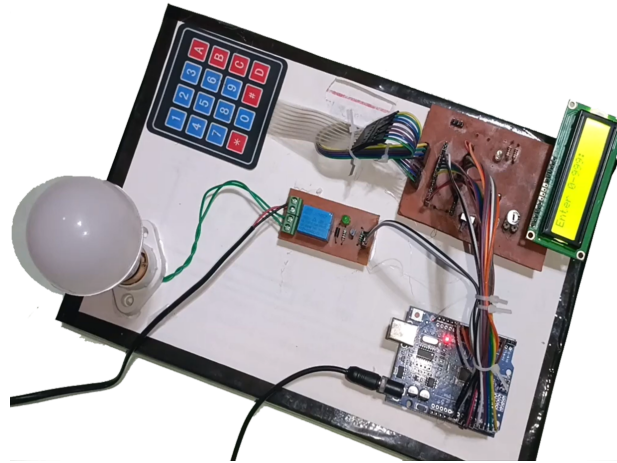

Testing Life Arduino

Available offer

- **Free Shipping** above Rs999.
- Pay with UPI QR [Coupons](#)
- **Special Bulk D** Companies and
- Get Special Dis 9109087333.

Highlights

Branding Free Pr

- No Brand Name/ Projects
- 100% Working p
- Tested Project &

Documentation

- Free Project Syn
- Printed Short Re
- Printable Soft co

Support

- Demo Video – **Embedded below**
- Technical Support – WhatsApp@9109087333
- [Get Discount Coupon](#)

Delivery Time

- **Handling Period** : 1-2 Days
- **Transit Time** :3-5 Days (Approx.)
- **Delivery Time** : Handling Period + Transit Time (4-7 Days Approx.)

[Read More](#)

SKU: PH_EP_141

Price: ~~₹5,000.00~~ Original price was: ₹5,000.00.₹
2,300.00Current price is: ₹2,300.00.

Stock: instock

Categories: [Arduino](#), [Engineering project](#), [Projects](#)

Tags: [Arduino Project](#), [destiny lab](#), [dret](#), [electrical and electronics engineering project](#), [electrical gadget](#), [electrical project](#), [electronic project](#), [engineering project](#), [free project idea](#), [Inspire Award project](#), [new project](#), [Project hub](#), [project hub bharat](#), [school project](#)

Product Description

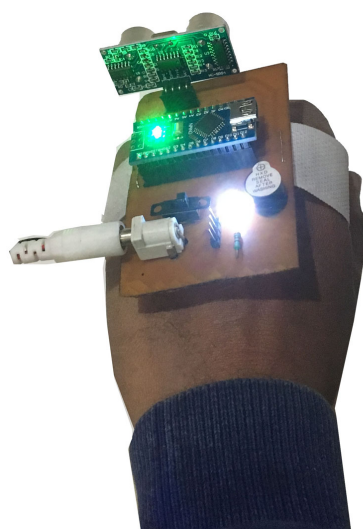

Third Eye for Arduino

Available offer

- **Free Shipping** above Rs999.
- Pay with UPI QR [Coupons](#)
- **Special Bulk D** Companies and

- Get Special Discount Coupon – WhatsApp@9109087333.

Highlights

Branding Free Project / Activity kit

- No Brand Name/Logo/Watermark on Components, PCB & Projects
- 100% Working project
- Tested Project & Activity kits

Documentation

- Free Project Synopsis – **Embedded below**
- Printed Short Report
- Printable Soft copy of Project Report

Support

- Demo Video – **Embedded below**
- Technical Support – WhatsApp@9109087333
- [Get Discount Coupon](#)

Delivery Time

- **Handling Period** : 1-2 Days
- **Transit Time** :3-5 Days (Approx.)
- **Delivery Time** : Handling Period + Transit Time (4-7 Days Approx.)

[Click Here to Buy Do It Yourself Kit](#)

[Read More](#)

SKU: PH_EP_001

Price: ~~₹2,320.00~~ Original price was: ₹2,320.00.₹
1,369.00Current price is: ₹1,369.00.

Stock: instock

Categories: [Arduino](#), [Engineering project](#), [Exhibition Models & Inspire Award](#), [Projects](#), [Technology &](#)

[Innovation](#), [Wearable Technology](#)

Tags: [Arduino IDE download](#), [Arduino programming tutorial](#), [Arduino project for students](#), [Assistive technology for the visually impaired](#), [Audio feedback device](#), [Electrical engineering project](#), [Electronics engineering project](#), [Engineering student projects](#), [Exhibition project](#), [Obstacle detection device](#), [School project ideas](#), [Third Eye for the Blind](#), [Ultrasonic sensors](#), [Wearable technology](#)

Product Description

Abstract:

According to estimates from the World Health Organization (WHO) Prevention of Blindness and Deafness Program: About **285 million people** are visually impaired worldwide: 39 million are blind and 246 million have low vision. Now a days there are so many instruments and smart devices for visually impaired peoples for navigation but most of them have certain problems for carrying and the major drawbacks is those need a lot of training to use. So the aim of the project is to develop a cheap and more efficient way to help visually impaired to navigate with greater comfort, speed and confidence.

Existing Systems & their problems:

1. Blind sticks- May easily crack/break; the stick may get stuck at pavement cracks of different objects.
2. Smart devices (eg: Vision a torch for blinds)- **Cannot be carried easily**, needs a lot of training to use

Solution:

To solve this problem we are going to make one of the best wearable technologies based innovative device which will detects nearby objects or obstacles and notify with buzzer & vibrators. This devices is called “**THIRD EYE FOR BLIND PERSON**” This technology will resolves all the problems of existing technologies. This device will help the blind to navigate without holding a stick. Simply wear it as a band or cloth and it can function very accurately and they only need a very little training to use it.

[Download Free Project Synopsis](#)

[Working Video](#)

Disclaimer:

This is a handmade complete working Models, Projects & Activity kits supported by rough study material to make a suitable projects report by the student. It is using Cardboard/Wooden base, Paper, Foam based board, stationary items, Electronic-Electrical Components, Mechanical & Scientific goods as per the requirement of a particular model. Colour of product and decoration item may be varying according to availability of material but we make ensure that we will deliver the product with same working, structure and dimensions as describe in product description section.

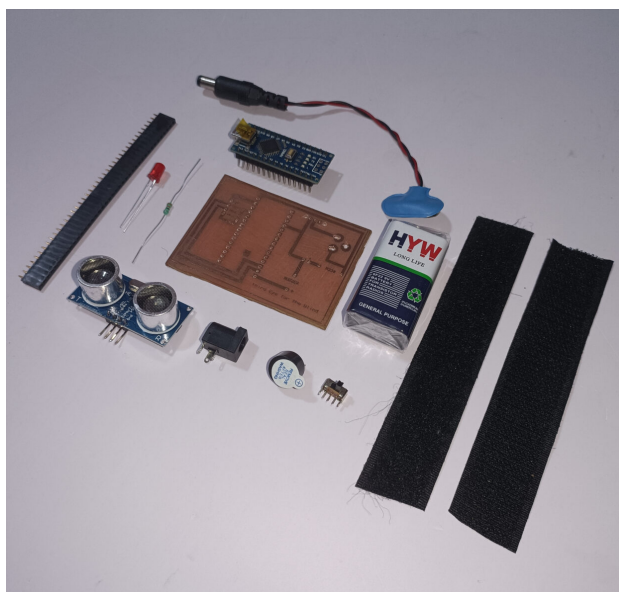

Third Eye for Arduino-DIY

Available offer

- **Free Shipping** above Rs999.
- Pay with UPI QR [Coupons](#)
- **Special Bulk D** Companies and m
- Get Special Dis 9109087333.

Highlights

Branding Free Pr

- No Brand Name/ Projects
- 100% Working p
- Tested Project &

Documentation

- Free Project Synopsis – **Embedded below**
- Printed Short Report
- Printable Soft copy of Project Report

Support

- Demo Video – **Embedded below**
- Technical Support – WhatsApp@9109087333
- [Get Discount Coupon](#)

Delivery Time

- **Handling Period** : 1-2 Days
- **Transit Time** :3-5 Days (Approx.)
- **Delivery Time** : Handling Period + Transit Time (4-7 Days Approx.)

NOTE: This Kit Includes Pre-programmed Arduino Board you don't need to upload code until you have to change anything.

NOTE: This kit required soldering & circuit testing skills, buy this kit if you have good soldering skills, otherwise you can also buy 'ready to use' project for same topic.

[Click Here to Buy Ready to Use Kit.](#)

[Read More](#)

SKU: PH_EPK_001

Price: ~~₹3,000.00~~ Original price was: ₹3,000.00. ₹1,299.00 Current price is: ₹1,299.00.

Stock: instock

Categories: [Arduino](#), [Engineering project kit \(EPK\)](#), [Hobby DIY kits](#), [WEARABLE TECHNOLOGY](#)

Tags: [Arduino IDE download](#), [Arduino programming tutorial](#), [Arduino project for students](#), [Assistive technology for the visually impaired](#), [Audio feedback device](#), [Electrical engineering project](#), [Electronics engineering project](#), [Engineering student projects](#),

[Exhibition project](#), [Obstacle detection device](#), [School project ideas](#), [Third Eye for the Blind](#), [Ultrasonic sensors](#), [Wearable technology](#)

Product Description

Kit Includes :

- Electronic Parts (listed in product image)
- Circuit Diagram
- Project Code
- Printed Circuit Board (PCB)
- Printed Short Report

Prerequisite Requirements

Hardware :

1. [Soldering Iron \(Buy Now \)](#)
2. [Soldering Paste \(Buy Now \)](#)
3. [Soldering Wire \(Buy Now \)](#)
4. [Soldering Stand \(Buy Now\)](#)
5. [Wire Cutter \(Buy Now\)](#)
6. [Screw Driver \(Buy Now\)](#)

Software :

1. Arduino IDE (optional) - [Download Now](#)

[Demo Video - How to Download Arduino IDE ?](#)

Skills:

1. Arduino Programming (optional)
2. Soldering ([Click Here for Free Tutorial](#))
3. Circuit Testing

Abstract:

According to estimates from the World Health Organization (WHO) Prevention of Blindness and Deafness Program: About **285 million people** are visually impaired worldwide: 39 million are

blind and 246 million have low vision. Now a days there are so many instruments and smart devices for visually impaired peoples for navigation but most of them have certain problems for carrying and the major drawbacks is those need a lot of training to use. So the aim of the project is to develop a cheap and more efficient way to help visually impaired to navigate with greater comfort, speed and confidence.

Existing Systems & their problems:

1. Blind sticks- May easily crack/break; the stick may get stuck at pavement cracks of different objects.
2. Smart devices (eg: Vision a torch for blinds)- **Cannot be carried easily**, needs a lot of training to use

Solution:

To solve this problem we are going to make one of the best wearable technologies based innovative device which will detects nearby objects or obstacles and notify with buzzer & vibrators. This devices is called “**THIRD EYE FOR BLIND PERSON**” This technology will resolves all the problems of existing technologies. This device will help the blind to navigate without holding a stick. Simply wear it as a band or cloth and it can function very accurately and they only need a very little training to use it.

[Download Free Project Synopsis](#)

[Working Video](#)

Disclaimer:

This is a handmade complete working Models, Projects & Activity kits supported by rough study material to make a suitable projects report by the student. It is using Cardboard/Wooden base, Paper, Foam based board, stationary items, Electronic-Electrical Components, Mechanical & Scientific goods as per the requirement of a particular model. Colour of product and decoration item may be varying according to availability of material but we make ensure that we will deliver the product with same working, structure and dimensions as describe in product description section.

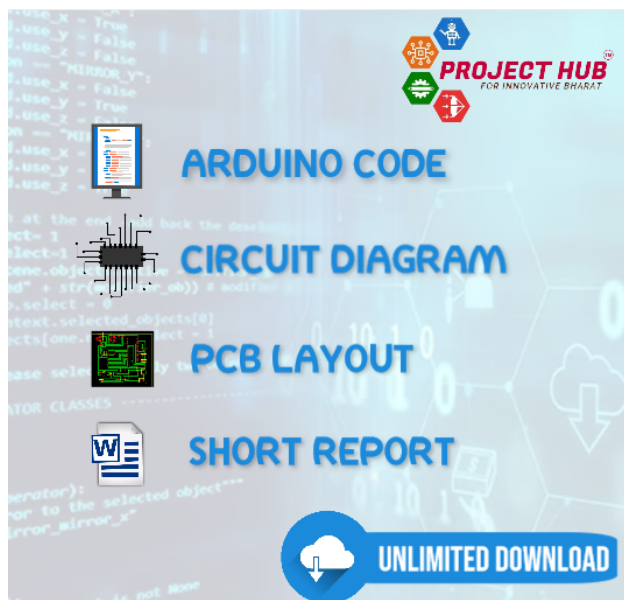

Third Eye for the Blind-Digital Bundle

Support

- Demo Video – **Embedded below**
- Technical Support – WhatsApp@9109087333
- [Get Discount Coupon](#)

[Click Here to Buy Ready to Use Kit.](#) [Click Here to Buy Do It Yourself Kit](#)

[Read More](#)

SKU: PH_DG_009

Price: ~~₹500.00~~ Original price was: ₹500.00. ₹49.00

Current price is: ₹49.00.

Stock: instock

Categories: [Digital Products](#), [Project Codes](#)

Product Description

Bundle Includes :

1. Synopsis
2. Circuit Diagram
3. Project Code
4. Printed Circuit Board - PCB
5. Printed Short Report

Prerequisite Requirements

Hardware :

1. [Soldering Iron \(Buy Now \)](#)
2. [Soldering Paste \(Buy Now \)](#)
3. [Soldering Wire \(Buy Now \)](#)
4. [Soldering Stand \(Buy Now\)](#)

5. [Wire Cutter \(Buy Now\)](#)
6. [Screw Driver \(Buy Now\)](#)
7. Electronic Parts
 - [Arduino Nano \(Buy Now\)-1](#)
 - [Ultrasonic Module \(Buy Now\)- 1](#)
 - [Buzzer \(Buy Now\) - 1](#)
 - [Slide Switch \(Buy Now\)- 1](#)
 - [DC Socket \(Buy Now\)- 1](#)
 - [DC Pin \(Buy Now\)- 1](#)
 - [Resistor - 470 Ohm \(Buy Now\)-1](#)
 - [LED \(Buy Now\)- 1](#)
 - Printed Circuit Board - 1
 - [DC Battery 9V \(Buy Now\) - 1](#)
 - [Female Header \(Buy Now\)- 1](#)

Software :

1. Arduino IDE - [Download Now](#)

[Demo Video - How to Download Arduino IDE ?](#)

Skills:

1. PCB printing at Home
2. Soldering ([Click Here for Free Tutorial](#))
3. Arduino Programming (optional)
4. Program uploading in Arduino
5. Circuit Testing

-
- **DO NOT CHANGE ANYTHING IN THE PROGRAM. ARDUINO CODES ARE CASE SENSITIVE, ON CHANGING OF SINGAL WORD CAN OCCUR COMPILING ERROR.**
 - **COPY & PASTE PROGRAM INTO ARDUINO IDE**
 - **DOWNLOAD ARDUINO IDE FROM <https://www.arduino.cc/en/software>.**
-

Abstract:

According to estimates from the World Health Organization (WHO) Prevention of Blindness and Deafness Program: About **285 million people** are visually impaired worldwide: 39 million are blind and 246 million have low vision. Now a days there are so many instruments and smart devices for visually impaired peoples for navigation but most of them have certain problems for

carrying and the major drawback is those need a lot of training to use. So the aim of the project is to develop a cheap and more efficient way to help visually impaired to navigate with greater comfort, speed and confidence.

Existing Systems & their problems:

1. Blind sticks- May easily crack/break; the stick may get stuck at pavement cracks of different objects.
2. Smart devices (eg: Vision a torch for blinds)- **Cannot be carried easily**, needs a lot of training to use

Solution:

To solve this problem we are going to make one of the best wearable technologies based innovative device which will detect nearby objects or obstacles and notify with buzzer & vibrators. This device is called "**THIRD EYE FOR BLIND PERSON**" This technology will resolve all the problems of existing technologies. This device will help the blind to navigate without holding a stick. Simply wear it as a band or cloth and it can function very accurately and they only need a very little training to use it.

[Download Free Project Synopsis](#)

Working Video:



**To assemble
comprising
(on/off) swi
power soure**

Kit Includes:

- Project Kit
- 9V Battery
- Print Short R

Available offers:

- **Free Shipping Offer** - Avail free shipping on all orders above Rs999.
- **Pay with UPI QR Code & Get 5% Special Discount.**/[Coupons](#)
- **Special Bulk Discounts** - for colleges, Schools, Companies and resellers. /[Contact Us](#).
- **Get Special Discount Coupon** - WhatsApp@9109087333.

Highlights Branding Free Project / Activity kit

- No Brand Name/Logo/Watermark on Components, PCB & Projects
- 100% Working project
- Tested Project & Activity kits

Documentation

- Printed Short Report
- Printable Soft copy of Project Report

Support

- Demo Video – **Embedded below**
- Technical Support – WhatsApp@9109087333
- [Get Discount Coupon](#)

[Read More](#)

SKU: PH_SPE_60

Price:

Stock: instock

Categories: [Electronics](#), [General science](#), [Physics](#), [Projects](#), [School Project & Experiment](#)

Product Description



To Measure Current and Continuity of using a Multimeter

Kit Includes:

- **Project Kit**
- **9V Battery**
- **Print Short R**

Available offers:

- **Free Shipping**
orders above ₹
- **Pay with UPI**
Discount./[Coup](#)
- **Special Bulk**
Companies an
- **Get Special D**
WhatsApp@91

Highlights Brand

- No Brand Name
PCB & Projects
- 100% Working
- Tested Project

Documentation

- Printed Short F
- Printable Soft

Support

- Demo Video –
- Technical Supp
- [Get Discount C](#)

[Read More](#)

SKU: PH_SPE_63

Price: ₹988.00 Original price was: ₹988.00. ₹583.00
Current price is: ₹583.00.

Stock: instock

Categories: [Electronics](#), [General science](#), [Physics](#),
[Projects](#), [School Project & Experiment](#)

Product Description

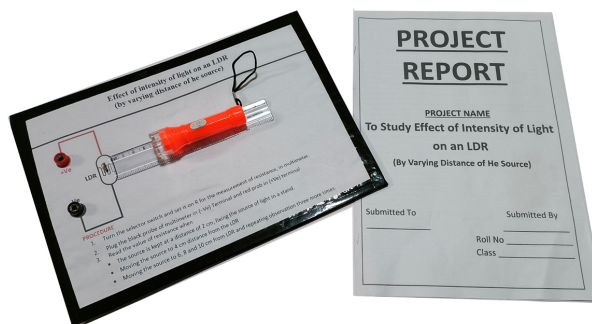

To Study Effect of Intensity of Light On an LDR

Package Includes

Branding Free

- No Brand Name
- PCB & Projects
- Tested Activity

Documentation

- Free Project Syllabus
- Printed instructions

Support

- Working Video
- Technical Support
- Get Discount Code

[Read More](#)

SKU: PH_SPE_40

Price: ₹332.00 Original price was: ₹332.00.
Current price is: ₹199.00.

Stock: instock

Categories: [Electronics](#), [Physics](#), [Projects](#), [School Project & Experiment](#)

Tags: [class 12th science project and experiment](#), [new science project](#)

Product Description

Download Free Project Synopsis

Disclaimer

This is a handmade complete working Models, Projects & Activity kits supported by rough study material to make a suitable projects report by the student. It is using Cardboard/Wooden base, Paper, Foam based board, stationary items, Electronic-Electrical Components, Mechanical & Scientific goods as per the requirement of a particular model. Colour of product and decoration item may be varying according to availability of material but we make ensure that we will deliver the product with same working, structure and dimensions as describe in product description section.

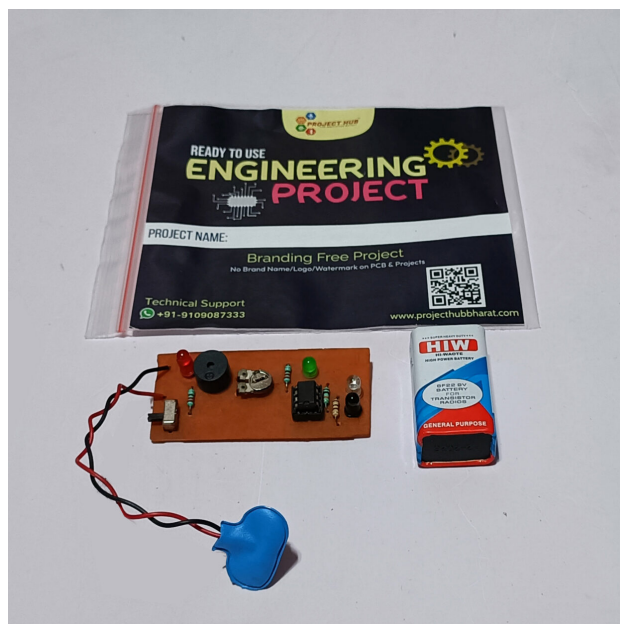

Touch less Handmade

Available offer

- **Free Shipping** above Rs999.
- COD available in above 999.
- Pay with UPI QR [Coupons](#)
- **Special Bulk D** Companies and
- Get Special Disc

Highlights

Branding Free Project / Activity kit

- No Brand Name/Logo/Watermark on Components, PCB & Projects
- 100% Working project
- Tested Project & Activity kits

Documentation

- Free Project Synopsis – **Embedded below**
- Printed Short Report
- Printable Soft copy of Project Report

Support

- Demo Video – **Embedded below**
- Technical Support – WhatsApp@9109087333
- [Get Discount Coupon](#)

Click Here to Buy Do It Yourself Kit

[Read More](#)

SKU: PH_EP_023

Price: ~~₹416.00~~ Original price was: ₹416.00. ₹245.00
Current price is: ₹245.00.

Stock: instock

Categories: [Engineering project](#), [IC & Transistor](#), [Mini Project](#), [Projects](#)

Product Description

INTRODUCTION:

We all have a doorbell at our homes. When a guest comes to our house, they search for the doorbell switch and then ring it to let us know their presence. If who came to our house and unable to find doorbell, else person is so short then they cannot find the doorbell in this case we need a solution that can find the presence of a person and rings the doorbell automatically.

Here we are making an object sensing based “**Touch Less Doorbell**” using infrared transceiver pair and some locally available components. It can detect the presence of a person and then if the person is detected, the doorbell is automatically turned ON when the person is in-front of the door. The touchless doorbell project is designed to provide a contactless alternative for ringing doorbells, eliminating the need for physical buttons or switches. This project employs the LM358 IC, an IR receiver and transmitter pair, and a 10k preset. By utilizing infrared technology, the system detects hand gestures and triggers the doorbell, enhancing convenience and hygiene.

AIM:

The aim of this project is to develop a touchless doorbell system that enables users to ring the doorbell without physical contact. By using hand gestures to activate the doorbell, this project promotes cleanliness, especially in public spaces where multiple people may use the doorbell.

PRINCIPLE:

The touchless doorbell project operates on the principle of infrared sensing. Infrared light is emitted by the IR transmitter and detected by the IR receiver. When an object, such as a hand, interrupts the infrared beam between the transmitter and receiver, the system recognizes the gesture and activates the doorbell.

[Download Free Project Synopsis](#)

Working Video

Disclaimer:

This is a handmade complete working Models, Projects & Activity kits supported by rough study material to make a suitable projects report by the student. It is using Cardboard/Wooden base, Paper, Foam based board, stationary items, Electronic-Electrical Components, Mechanical & Scientific goods as per the requirement of a particular model. Colour of product and decoration item may be varying according to availability of material but we make ensure that we will deliver the product with same working, structure and dimensions as describe in product description section.



Touch less o Sensor- DIY

Available offer

- **Free Shipping** above Rs999.
- COD available in above 999.
- Pay with UPI QR [Coupons](#)
- **Special Bulk D** Companies and
- Get Special Disc

Highlights

Branding Free Pr

- No Brand Name/ Projects
- 100% Working p
- Tested Project &

Documentation

- Free Project Syn
- Printed Short Re
- Printable Soft co

Support

- Demo Video – **En**
- Technical Suppo
- [Get Discount Co](#)

[Click Here to Buy R](#)
[Read More](#)

SKU: PH_EPK_090

Price: ₹400.00 Original price was: ₹400.00. ~~₹350.00~~
Current price is: ₹350.00.

Stock: instock

Categories: [Hobby DIY kits](#), [IC & TRANSISTOR](#)

Tags: [Arduino Project](#), [Contactless Doorbell](#), [DIY electronics](#), [Home Automation](#), [Home Security](#), [Infrared Motion Detection](#), [Internet of Things \(IoT\)](#), [Sensor Technology](#), [Smart Home Project](#), [Touch-Free Doorbell](#), [Touchless Doorbell](#), [Wireless Doorbell](#)

Product Description

Kit Includes :

- Electronic Parts (listed in product image)
- Circuit Diagram
- Printed Circuit Board (PCB)
- Printed Short Report

Prerequisite Requirements

Hardware :

1. [Soldering Iron \(Buy Now \)](#)
2. [Soldering Paste \(Buy Now \)](#)
3. [Soldering Wire \(Buy Now \)](#)
4. [Soldering Stand \(Buy Now\)](#)
5. [Wire Cutter \(Buy Now\)](#)
6. [Screw Driver \(Buy Now\)](#)

Skills:

1. Soldering ([Click Here for Free Tutorial](#))
2. Circuit Testing

Introduction:

We all have a doorbell at our homes. When a guest comes to our house, they search for the doorbell switch and then ring it to let us know their presence. If who came to our house and unable to find doorbell, else person is so short then they cannot find the doorbell in this case we need a solution that can find the presence of a person and rings the doorbell automatically. Here we are making an object sensing based “**Touch Less Doorbell**” using infrared transceiver pair and some locally available components. It can detect the presence of a person and then if the person is detected, the doorbell is automatically turned ON when the person is in-front of the door. The touchless doorbell project is designed to provide a contactless alternative for ringing doorbells, eliminating the need for physical buttons or switches. This project employs the LM358 IC, an IR receiver and transmitter pair, and a 10k preset. By utilizing infrared technology, the system detects hand gestures and triggers the doorbell, enhancing convenience and hygiene.

Aim:

The aim of this project is to develop a touchless doorbell system that enables users to ring the doorbell without physical contact. By using hand gestures to activate the doorbell, this project promotes cleanliness, especially in public spaces where multiple people may use the doorbell.

Principle:

The touchless doorbell project operates on the principle of infrared sensing. Infrared light is emitted by the IR transmitter and detected by the IR receiver. When an object, such as a hand, interrupts the infrared beam between the transmitter and receiver, the system recognizes the gesture and activates the doorbell.

[Download Free Project Synopsis](#)

[Working Video](#)

Disclaimer:

This is a handmade complete working Models, Projects & Activity kits supported by rough study material to make a suitable projects report by the student. It is using Cardboard/Wooden base, Paper, Foam based board, stationary items, Electronic-Electrical Components, Mechanical & Scientific goods as per the requirement of a particular model. Colour of product and decoration item may be varying according to availability of material but we make ensure that we will deliver the product with same working, structure and dimensions as describe in product description section.



Transforma energy to m (Motor & w

Kit Includes:

- **Project Kit**
- **9V Battery**
- **Print Short R**

Available offers:

- **Free Shipping**
orders above ₹
- **Pay with UPI**
Discount./[Cou](#)
- **Special Bulk**
Companies an
- **Get Special D**
WhatsApp@91

Highlights Brand

- No Brand Nam
PCB & Projects
- 100% Working
- Tested Project

Documentation

- Printed Short P
- Printable Soft

Support

- Demo Video –
- Technical Supp
- [Get Discount C](#)

[Read More](#)

SKU: PH_SPE_119

Price:

Stock: instock

Categories: [Electronics](#), [General science](#), [Physics](#), [Projects](#), [School Project & Experiment](#)

Product Description



Transforma energy to e & wheel)

Kit Includes:

- **Project Kit**
- **9V Battery**
- **Print Short R**

Available offers:

- **Free Shipping**
orders above ₹
- **Pay with UPI**
Discount./[Cou](#)
- **Special Bulk**
Companies an
- **Get Special D**
WhatsApp@91

Highlights Brand

- No Brand Nam
PCB & Projects
- 100% Working
- Tested Project

Documentation

- Printed Short Report
- Printable Soft copy of Project Report

Support

- Demo Video – **Embedded below**
- Technical Support – WhatsApp@9109087333
- [Get Discount Coupon](#)

[Read More](#)

SKU: PH_SPE_120

Price:

Stock: instock

Categories: [Electronics](#), [General science](#), [Physics](#), [Projects](#), [School Project & Experiment](#)

Product Description
