

## Nuclear Fus

### Kit Includes:

- **Project Kit**
- **9V Battery**
- **Print Short R**

### Available offers:

- **Free Shipping**  
orders above ₹
- **Pay with UPI**  
Discount./[Cou](#)
- **Special Bulk**  
Companies an
- **Get Special D**  
WhatsApp@91

### Highlights Brand

- No Brand Nam
- PCB & Projects
- 100% Working
- Tested Project

### Documentation

- Printed Short F
- Printable Soft

### Support

- Demo Video –
- Technical Supp
- [Get Discount C](#)

[Read More](#)

**SKU:** PH\_SPE\_115

**Price:**



**Stock:** instock

**Categories:** [Electronics](#), [General science](#), [Physics](#), [Projects](#), [School Project & Experiment](#)

## Product Description

---

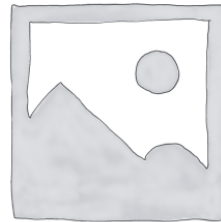

## Nuclear Fusion Fission

### Kit Includes:

- **Project Kit**
- **9V Battery**
- **Print Short R**

### Available offers:

- **Free Shipping** orders above ₹
- **Pay with UPI** Discount./[Cou](#)
- **Special Bulk** Companies an
- **Get Special D** WhatsApp@91

### Highlights Brand

- No Brand Name PCB & Projects
- 100% Working
- Tested Project

### Documentation

- Printed Short F
- Printable Soft

### Support

- Demo Video – **Embedded below**
- Technical Support – WhatsApp@9109087333
- [Get Discount Coupon](#)

[Read More](#)

**SKU:** PH\_SPE\_117

**Price:**

**Stock:** instock

**Categories:** [Electronics](#), [General science](#), [Physics](#), [Projects](#), [School Project & Experiment](#)

## Product Description

---



## Obstacle Av Arduino & U

### Available offer

- **Free Shipping**  
orders above ₹
- Pay with UPI Q  
Discount./ [Cou](#)
- **Special Bulk**  
Companies an
- Get Special Dis  
WhatsApp@91

### Highlights

#### Branding Free Pr

- No Brand Nam  
PCB & Projects
- 100% Working
- Tested Project

### Documentation

- Free Project Synopsis – **Embedded below**
- Printed Short Report
- Printable Soft copy of Project Report

### Support

- Demo Video – **Embedded below**
- Technical Support – WhatsApp@9109087333
- [Get Discount Coupon](#)

### Delivery Time

- **Handling Period** : 1-2 Days
- **Transit Time** :3-5 Days (Approx.)
- **Delivery Time** : Handling Period + Transit Time (4-7 Days Approx.)

Click Here to Buy Do It Yourself Kit

[Read More](#)

**SKU:** PH\_EP\_105

**Price:**

**Stock:** instock

**Categories:** [Arduino](#), [Engineering project](#), [Mechanical Projects](#), [Robotics](#)

## Product Description

### Download Free Project Synopsis

---

### Working Video

---

#### Disclaimer:

This is a handmade complete working Models, Projects & Activity kits supported by rough study material to make a suitable projects report by the student. It is using Cardboard/Wooden base, Paper, Foam based board, stationary items, Electronic-Electrical Components, Mechanical &

Scientific goods as per the requirement of a particular model. Colour of product and decoration item may be varying according to availability of material but we make ensure that we will deliver the product with same working, structure and dimensions as describe in product description section.

---



## Obstacle Av Microcontro

### Available offer

- **Free Shipping**  
orders above ₹
- Pay with UPI Q  
Discount./ [Cou](#)
- **Special Bulk**  
Companies an
- Get Special Dis  
WhatsApp@91

### Highlights

#### Branding Free Pr

- No Brand Nam  
PCB & Projects
- 100% Working
- Tested Project

### Documentation

- Free Project Sy
- Printed Short F
- Printable Soft

### Support

- Demo Video – **Embedded below**
- Technical Support – WhatsApp@9109087333
- [Get Discount Coupon](#)

### **Delivery Time**

- **Handling Period** : 1-2 Days
- **Transit Time** :3-5 Days (Approx.)
- **Delivery Time** : Handling Period + Transit Time (4-7 Days Approx.)

Click Here to Buy Do It Yourself Kit

[Read More](#)

**SKU:** PH\_EP\_098

**Price:**

**Stock:** instock

**Categories:** [Engineering project](#), [Mechanical](#), [Projects](#), [Robotics](#)

## **Product Description**

### **Download Free Project Synopsis**

---

### **Working Video**

---

### **Disclaimer:**

This is a handmade complete working Models, Projects & Activity kits supported by rough study material to make a suitable projects report by the student. It is using Cardboard/Wooden base, Paper, Foam based board, stationary items, Electronic-Electrical Components, Mechanical & Scientific goods as per the requirement of a particular model. Colour of product and decoration item may be varying according to availability of material but we make ensure that we will deliver the product with same working, structure and dimensions as describe in product description section.

---



## Obstacle Avoidance Robot using ultrasonic sensor

### Available offers

- **Free Shipping** on all orders above ₹ 1000
- Pay with UPI QR Code, Bank Discount./ [Coupons](#)
- **Special Bulk Price** for Companies and Institutions
- Get Special Discount on [WhatsApp@919909909909](#)

### Highlights

#### Branding Free Product

- No Brand Name on PCB & Projects
- 100% Working Project
- Tested Project

#### Documentation

- Free Project System
- Printed Short Form
- Printable Software

#### Support

- Demo Video – [YouTube](#)
- Technical Support – [WhatsApp](#)
- [Get Discount Coupon](#)

#### Delivery Time

- **Handling Period** : 1-2 Days
- **Transit Time** :3-5 Days (Approx.)
- **Delivery Time** : Handling Period + Transit Time (4-7 Days Approx.)

Click Here to Buy Do It Yourself Kit

[Read More](#)

**SKU:** PH\_EP\_112

**Price:**

**Stock:** instock

**Categories:** [Engineering project](#), [Mechanical](#), [Projects](#), [Robotics](#)

## Product Description

## Download Free Project Synopsis

---

## Working Video

---

### **Disclaimer:**

This is a handmade complete working Models, Projects & Activity kits supported by rough study material to make a suitable projects report by the student. It is using Cardboard/Wooden base, Paper, Foam based board, stationary items, Electronic-Electrical Components, Mechanical & Scientific goods as per the requirement of a particular model. Colour of product and decoration item may be varying according to availability of material but we make ensure that we will deliver the product with same working, structure and dimensions as describe in product description section.

---





## OR Gate usi

### Kit Includes:

- **Project Kit**
- **9V Battery**
- **Print Short R**

### Available offers:

- **Free Shipping**  
orders above ₹
- **Pay with UPI**  
Discount./[Coupo](#)
- **Special Bulk**  
Companies an
- **Get Special D**  
WhatsApp@91

### Highlights Brand

- No Brand Nam
- PCB & Projects
- 100% Working
- Tested Project

### Documentation

- Printed Short F
- Printable Soft

### Support

- Demo Video –
- Technical Supp
- [Get Discount C](#)

[Read More](#)

**SKU:** PH\_SPE\_88

**Price:** ₹340.00 Orig  
Current price is: ₹2

**Stock:** instock

**Categories:** [Electronics](#), [General science](#), [Physics](#), [Projects](#), [School Project & Experiment](#)

## Product Description

---

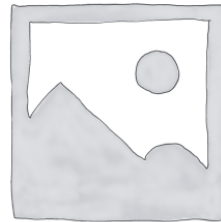

## OR Gate using

### Kit Includes:

- **Project Kit**
- **9V Battery**
- **Print Short R**

### Available offers:

- **Free Shipping** on orders above ₹
- **Pay with UPI** for 10% Discount./[Cou](#)
- **Special Bulk** prices for Companies and
- **Get Special D**iscount on WhatsApp@91

### Highlights Brand

- No Brand Name PCB & Projects
- 100% Working
- Tested Project

### Documentation

- Printed Short F
- Printable Soft

### Support

- Demo Video –

- Technical Support – WhatsApp@9109087333
- [Get Discount Coupon](#)

[Read More](#)

**SKU:** PH\_SPE\_89

**Price:**

**Stock:** instock

**Categories:** [Electronics](#), [General science](#), [Physics](#), [Projects](#), [School Project & Experiment](#)

## Product Description

---

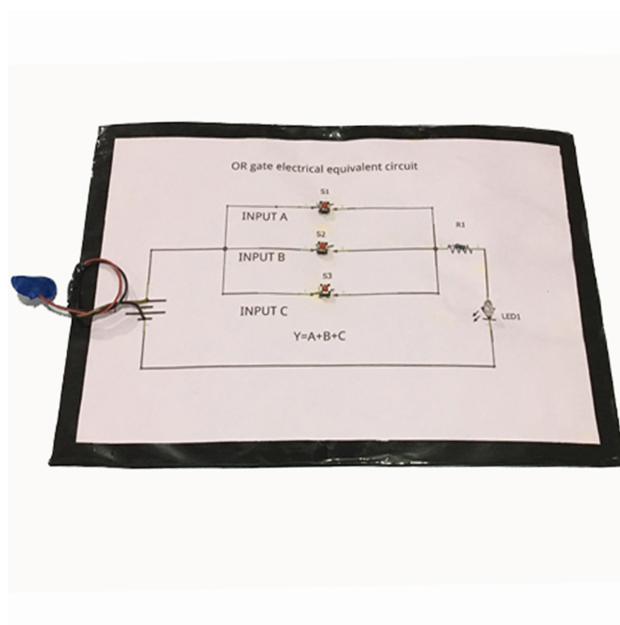

**OR logic gate  
equivalent circuit**

**Package Includes**

**Branding Free**

- No Brand Name
- PCB & Projects
- Tested Activity

**Documentation**

- Free Project Sy
- Printed instruc

**Support**

- Working Video
- Technical Supp
- Get Discount C

[Read More](#)

**SKU:** PH\_SPE\_86

**Price:** ₹336.00 Original price was: ₹336.00. ~~₹198.00~~  
Current price is: ₹198.00.

**Stock:** instock

**Categories:** [Electronics](#), [Logic Gate](#), [Physics](#), [Projects](#), [School Project & Experiment](#)

**Tags:** [class 12th science project and experiment](#), [logic gate](#), [new science project](#)

## Product Description

## Download Free Project Synopsis

### Disclaimer

This is a handmade complete working Models, Projects & Activity kits supported by rough study material to make a suitable projects report by the student. It is using Cardboard/Wooden base, Paper, Foam based board, stationary items, Electronic-Electrical Components, Mechanical & Scientific goods as per the requirement of a particular model. Colour of product and decoration item may be varying according to availability of material but we make ensure that we will deliver the product with same working, structure and dimensions as describe in product description section.

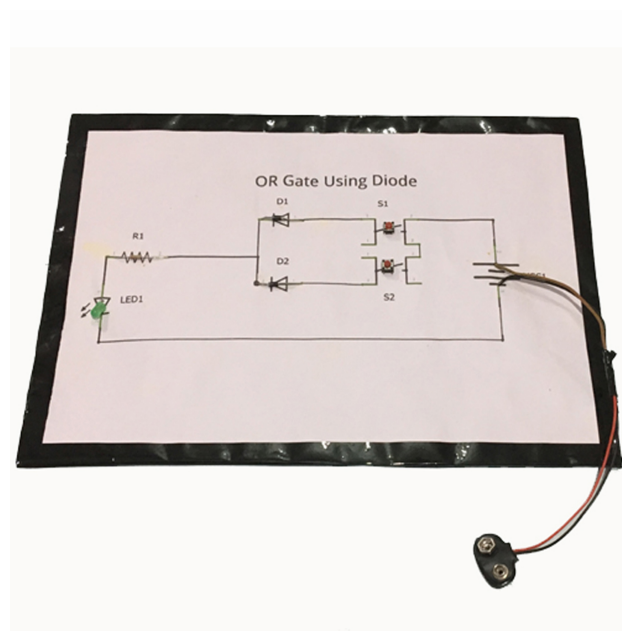

## OR logic gate

## Package Includes

## Branding Free

- No Brand Name
- PCB & Projects
- Tested Activity

## Documentation

- Free Project Sy

- Printed instruction booklet

## Support

- Working Video – **Embedded Below**
- Technical Support – WhatsApp@9109087333
- Get Discount Coupon - WhatsApp@9303254433

[Read More](#)

**SKU:** PH\_SPE\_87

**Price:** ~~₹340.00~~ Original price was: ₹340.00. ₹201.00  
Current price is: ₹201.00.

**Stock:** instock

**Categories:** [Electronics](#), [Logic Gate](#), [Physics](#), [Projects](#), [School Project & Experiment](#)

**Tags:** [class 12th science project and experiment](#), [logic gate](#), [new science project](#)

## Product Description

## Download Free Project Synopsis

### Disclaimer

This is a handmade complete working Models, Projects & Activity kits supported by rough study material to make a suitable projects report by the student. It is using Cardboard/Wooden base, Paper, Foam based board, stationary items, Electronic-Electrical Components, Mechanical & Scientific goods as per the requirement of a particular model. Colour of product and decoration item may be varying according to availability of material but we make ensure that we will deliver the product with same working, structure and dimensions as describe in product description section.

---

## OR logic gate using transistors

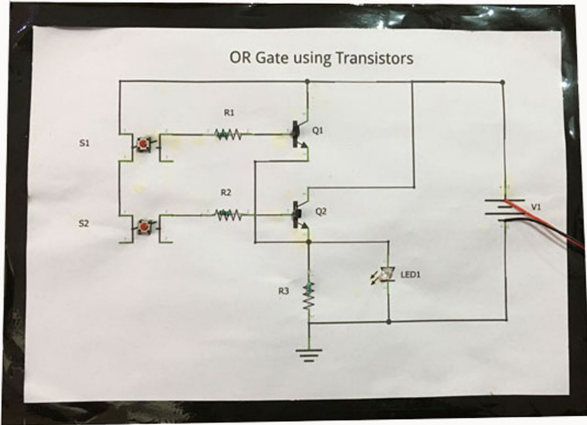

### Package Includes:

### Branding Free Activity kit

- No Brand Name/Logo/Watermark on Components, PCB & Projects
- Tested Activity kits

### Documentation

- Free Project Synopsis – **Embedded below**
- Printed instruction booklet

### Support

- Working Video – **Embedded Below**
- Technical Support – WhatsApp@9109087333
- Get Discount Coupon – WhatsApp@9303254433

[Read More](#)

**SKU:** PH\_SPE\_90

**Price:** ~~₹368.00~~ Original price was: ₹368.00. ₹217.00  
Current price is: ₹217.00.

**Stock:** instock

**Categories:** [Electronics](#), [Logic Gate](#), [Physics](#), [Projects](#), [School Project & Experiment](#)

**Tags:** [class 12th science project and experiment](#), [logic gate](#), [new science project](#)

### Product Description

## Download Free Project Synopsis

## Disclaimer

This is a handmade complete working Models, Projects & Activity kits supported by rough study material to make a suitable projects report by the student. It is using Cardboard/Wooden base, Paper, Foam based board, stationary items, Electronic-Electrical Components, Mechanical & Scientific goods as per the requirement of a particular model. Colour of product and decoration item may be varying according to availability of material but we make ensure that we will deliver the product with same working, structure and dimensions as describe in product description section.

---



## Orange and Green 3D home, DIY Paper folding house, Craft Kit for Kids

### Support

- Demo Video - [Embedded below](#)
- Technical Support - WhatsApp@9109087333
- Get Discount Coupon - WhatsApp@9303254433

[Read More](#)

**SKU:** PH\_DG\_001

**Price:** ₹20.00 Original price was: ₹20.00. ~~₹5.00~~ Current price is: ₹5.00.

**Stock:** instock

**Categories:** [Digital Products](#), [Printable Templates](#)

### Product Description

---

## Oxygen Cyc

### Kit Includes:

- **Project Kit**
- **9V Battery**
- **Print Short R**

### Available offers:

- **Free Shipping**  
orders above ₹
- **Pay with UPI**  
Discount./[Coup](#)
- **Special Bulk**  
Companies an
- **Get Special D**  
WhatsApp@91

### Highlights Brand

- No Brand Nam
- PCB & Projects
- 100% Working
- Tested Project

### Documentation

- Printed Short F
- Printable Soft

### Support

- Demo Video –
- Technical Supp
- [Get Discount C](#)

[Read More](#)

**SKU:** PH\_SPE\_24

**Price:**

**Stock:** instock





**Categories:** [Biology](#), [General science](#), [Projects](#), [School Project & Experiment](#)

## Product Description

---



## Parking Lot

### Available offer

- **Free Shipping** above Rs999.
- Pay with UPI QR [Coupons](#)
- **Special Bulk D** Companies and r
- Get Special Dis 9109087333.

## Highlights

### Branding Free Pr

- No Brand Name/ Projects
- 100% Working p
- Tested Project &

### Documentation

- Free Project Syn
- Printed Short Re
- Printable Soft co

### Support

- Demo Video – **En**
- Technical Suppo

- [Get Discount Coupon](#)

### Delivery Time

- **Handling Period** : 1-2 Days
- **Transit Time** :3-5 Days (Approx.)
- **Delivery Time** : Handling Period + Transit Time (4-7 Days Approx.)

[Read More](#)

**SKU:** PH\_EP\_018

**Price:** ₹3,476.00 Original price was: ₹3,476.00.₹  
2,051.00Current price is: ₹2,051.00.

**Stock:** instock

**Categories:** [Arduino](#), [Engineering project](#), [Exhibition Models & Inspire Award](#), [Mechatronics](#), [Projects](#), [Technology & Innovation](#), [Transport](#)

## Product Description

### Parking Lot Gate Controller with Capacity Counter using 7 Segment Display / slot based parking lot

---

#### INTRODUCTION:

A parking lot gate controller using Arduino, a 7-segment display, and a servo motor can be built to manage the opening and closing of a parking lot gate and display relevant information. The system can include features like a numeric display for parking space availability for the gate closure. The aim of this project is to design and build a prototype of an automated parking system which will show the number of parking spaces left inside the parking lot. It will have a pre-installed number of maximum cars that can be parked. A conduction sensor will count the entry and exit of each car and open the barricade for the entry and exit. The entry and exit system can how ever be chosen. A display on the monitor outside the parking lot will show how many cars can still be parking inside the parking lot. In this project, 8 parking spaces have been allotted with only one entry/exit door.

---

[Download Free Project Synopsis](#)

---

## Working Video

---

### **Disclaimer:**

This is a handmade complete working Models, Projects & Activity kits supported by rough study material to make a suitable projects report by the student. It is using Cardboard/Wooden base, Paper, Foam based board, stationary items, Electronic-Electrical Components, Mechanical & Scientific goods as per the requirement of a particular model. Colour of product and decoration item may be varying according to availability of material but we make ensure that we will deliver the product with same working, structure and dimensions as describe in product description section.

---



## **Password b using Ardui**

### **Available offer**

- **Free Shipping**  
orders above ₹
- Pay with UPI Q  
Discount./ [Cou](#)
- **Special Bulk**  
Companies an
- Get Special Dis  
WhatsApp@91

### **Highlights**

#### **Branding Free Pr**

- No Brand Nam  
PCB & Projects
- 100% Working
- Tested Project

## Documentation

- Free Project Synopsis – **Embedded below**
- Printed Short Report
- Printable Soft copy of Project Report

## Support

- Demo Video – **Embedded below**
- Technical Support – WhatsApp@9109087333
- [Get Discount Coupon](#)

[Read More](#)

**SKU:** PH\_EP\_064

**Price:**

**Stock:** instock

**Categories:** [Arduino](#), [Engineering project](#), [Projects](#)

## Product Description

---

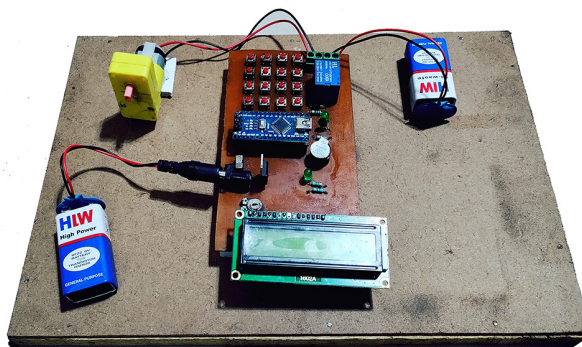

**Password b**  
**Arduino & P**

**Package Includ**

**Branding Free**

- No Brand Nam
- PCB & Projects
- 100% Working
- Tested Project

**Documentation**

- Free Project Synopsis – **Embedded below**
- Printed instruction booklet
- Printable Soft copy of Project Report
- PPT

## Support

- Demo Video – **Embedded below**
- Technical Support – WhatsApp@9109087333
- Get Discount Coupon – WhatsApp@9303254433

[Read More](#)

**SKU:** PH\_EP\_063

**Price:** ~~₹4,400.00~~ Original price was: ₹4,400.00. ₹  
2,350.00 Current price is: ₹2,350.00.

**Stock:** instock

**Categories:** [Arduino](#), [Engineering project](#), [Projects](#)

## Product Description

## Download Free Project Synopsis

## Working Video

This is a handmade complete working Models, Projects & Activity kits supported by rough study material to make a suitable projects report by the student. It is using Cardboard/Wooden base, Paper, Foam based board, stationary items, Electronic-Electrical Components, Mechanical & Scientific goods as per the requirement of a particular model. Colour of product and decoration item may be varying according to availability of material but we make ensure that we will deliver the product with same working, structure and dimensions as describe in product description section.

---



## Password b Arduino Uno Electric Doc

### Available offer

- **Free Shipping**  
orders above ₹
- Pay with UPI Q  
Discount./ [Cou](#)
- **Special Bulk**  
Companies an
- Get Special Dis  
WhatsApp@91

### Highlights

#### Branding Free Pr

- No Brand Nam  
PCB & Projects
- 100% Working
- Tested Project

#### Documentation

- Free Project Sy
- Printed Short F
- Printable Soft

#### Support

- Demo Video –
- Technical Supp
- [Get Discount C](#)

[Read More](#)

**SKU:** PH\_EP\_061

**Price:**

**Stock:** instock

**Categories:** [Arduino](#), [Engineering project](#), [Projects](#)

## Product Description

---



## Password D Arduino Na Keypad

### Available offer

- **Free Shipping**  
orders above ₹
- Pay with UPI Q  
Discount./ [Cou](#)
- **Special Bulk**  
Companies an
- Get Special Dis  
WhatsApp@91

### Highlights

#### Branding Free Pr

- No Brand Nam  
PCB & Projects
- 100% Working
- Tested Project

### Documentation

- Free Project Sy

- Printed Short Report
- Printable Soft copy of Project Report

### Support

- Demo Video – **Embedded below**
- Technical Support – WhatsApp@9109087333
- [Get Discount Coupon](#)

[Read More](#)

**SKU:** PH\_EP\_062

**Price:**

**Stock:** instock

**Categories:** [Arduino](#), [Engineering project](#), [Projects](#)

## Product Description

---



## Photocell Experiment To Study the Variation in Photoelectric Current with Intensity of Light

### Kit Includes:

- Project Kit
- 9V Battery
- Print Short Report

### Available offers:

- Free Shipping on orders above ₹1000
- Pay with UPI and get 5% Discount./[Coupon](#)
- Special Bulk Discounts for Companies and Institutions



- **Get Special Discount Coupon** –  
WhatsApp@9109087333.

### **Highlights Branding Free Project / Activity kit**

- No Brand Name/Logo/Watermark on Components, PCB & Projects
- 100% Working project
- Tested Project & Activity kits

### **Documentation**

- Printed Short Report
- Printable Soft copy of Project Report

### **Support**

- Demo Video – **Embedded below**
- Technical Support – WhatsApp@9109087333
- [Get Discount Coupon](#)

[Read More](#)

**SKU:** PH\_SPE\_160

**Price:**

**Stock:** instock

**Categories:** [Electronics](#), [General science](#), [Physics](#), [Projects](#), [School Project & Experiment](#)

## **Product Description**

---

# Photophobi Microcontro



## Available offer

- **Free Shipping**  
orders above ₹
- Pay with UPI Q  
Discount./ [Cou](#)
- **Special Bulk**  
Companies an
- Get Special Dis  
WhatsApp@91

## Highlights

### Branding Free Pr

- No Brand Nam  
PCB & Projects
- 100% Working
- Tested Project

### Documentation

- Free Project Sy
- Printed Short P
- Printable Soft

### Support

- Demo Video –
- Technical Supp
- [Get Discount C](#)

### Delivery Time

- **Handling Period** : 1-2 Days
- **Transit Time** :3-5 Days (Approx.)
- **Delivery Time** : Handling Period + Transit Time (4-7 Days Approx.)

[Click Here to Buy Do It Yourself Kit](#)

[Read More](#)

**SKU:** PH\_EP\_103

**Price:**

**Stock:** instock

**Categories:** [Engineering project](#), [Mechanical](#), [Projects](#), [Robotics](#)

## Product Description

## Download Free Project Synopsis

---

## Working Video

---

### **Disclaimer:**

This is a handmade complete working Models, Projects & Activity kits supported by rough study material to make a suitable projects report by the student. It is using Cardboard/Wooden base, Paper, Foam based board, stationary items, Electronic-Electrical Components, Mechanical & Scientific goods as per the requirement of a particular model. Colour of product and decoration item may be varying according to availability of material but we make ensure that we will deliver the product with same working, structure and dimensions as describe in product description section.

---

# Photosynth

## Kit Includes:

- **Project Kit**
- **9V Battery**
- **Print Short R**

## Available offers:

- **Free Shipping**  
orders above ₹
- **Pay with UPI**  
Discount./[Coupe](#)
- **Special Bulk**  
Companies an
- **Get Special D**  
WhatsApp@91

## Highlights Brand

- No Brand Nam
- PCB & Projects
- 100% Working
- Tested Project

## Documentation

- Printed Short F
- Printable Soft

## Support

- Demo Video –
- Technical Supp
- [Get Discount C](#)

[Read More](#)

**SKU:** PH\_SPE\_08

**Price:**

**Stock:** instock



**Categories:** [Biology](#), [General science](#), [Projects](#), [School Project & Experiment](#)

## Product Description

---



## Plant Life C

### Kit Includes:

- **Project Kit**
- **9V Battery**
- **Print Short R**

### Available offers:

- **Free Shipping**  
orders above ₹
- **Pay with UPI**  
Discount./[Cou](#)
- **Special Bulk**  
Companies an
- **Get Special D**  
WhatsApp@91

### Highlights Brand

- No Brand Name  
PCB & Projects
- 100% Working
- Tested Project

### Documentation

- Printed Short P
- Printable Soft

### Support

- Demo Video –
- Technical Supp

- [Get Discount Coupon](#)

[Read More](#)

**SKU:** PH\_SPE\_29

**Price:**

**Stock:** instock

**Categories:** [Biology](#), [Projects](#), [School Project & Experiment](#)

## Product Description

---



## Portable En

### Available offer

- **Free Shipping** above Rs999.
- COD available in above 999.
- Pay with UPI QR [Coupons](#)
- **Special Bulk D** Companies and
- Get Special Disc

### Highlights

### Branding Free Pr

- No Brand Name/ Projects
- 100% Working p
- Tested Project &

### Documentation

- Free Project Synopsis – **Embedded below**
- Printed Short Report
- Printable Soft copy of Project Report

### Support

- Demo Video – **Embedded below**
- Technical Support – WhatsApp@9109087333
- [Get Discount Coupon](#)

[Click Here to Buy Do It Yourself Kit](#)

[Read More](#)

**SKU:** PH\_EP\_028

**Price:** ~~₹3,908.00~~ Original price was: ₹3,908.00. ₹  
2,306.00 Current price is: ₹2,306.00.

**Stock:** instock

**Categories:** [Arduino](#), [Engineering project](#), [Exhibition Models & Inspire Award](#), [Projects](#), [Technology & Innovation](#)

**Tags:** [school science project](#), [science exhibition model](#), [security system](#)

## Product Description

### INTRODUCTION :

The Portable Environment Monitor is a project aimed at creating a device that can measure and display key environmental parameters such as air quality, temperature, humidity, and light intensity. The monitor utilizes an Arduino Nano microcontroller board along with sensors like MQ135, DHT11, and an LDR (Light Dependent Resistor) to collect data. The data is then displayed on an LCD16x2 display for easy interpretation. This project provides a compact and portable solution for monitoring environmental conditions in various settings.

### MARKET USES:

The Portable Environment Monitor has various potential market uses, including:

- Indoor Air Quality Monitoring: It can be utilized in homes, offices, and public buildings to monitor air quality, detect harmful gases, and ensure a healthy living and working

environment.

- **Environmental Research:** Scientists and researchers can use the monitor for field studies, analyzing pollution levels, and collecting data for further analysis.
- **Smart Agriculture:** The monitor can be employed in greenhouse environments to maintain optimal temperature, humidity, and light levels for plant growth.
- **Industrial Safety:** It can be utilized in industrial settings to monitor air quality and ensure a safe working environment for employees.
- **Educational Purposes:** The Portable Environment Monitor can be used as an educational tool to teach students about environmental monitoring and the importance of air quality.

## ADVANTAGES:

The Portable Environment Monitor offers several advantages:

- **Portability:** The device is compact and portable, allowing for easy deployment in various locations.
- **Real-time Monitoring:** It provides real-time data on temperature, humidity, gas concentration, and light intensity, allowing users to make informed decisions.
- **Cost-effective:** The components used in the project are relatively inexpensive and readily available, making it an affordable solution for environmental monitoring.
- **User-friendly Interface:** The LCD16x2 display provides a clear and easy-to-read interface for displaying environmental parameters.
- **Customizability:** The project can be expanded or modified to include additional sensors or functionality based on specific requirements.

---

[Download Free Project Synopsis](#)

**Working Video**

---

## Disclaimer:

This is a handmade complete working Models, Projects & Activity kits supported by rough study material to make a suitable projects report by the student. It is using Cardboard/Wooden base, Paper, Foam based board, stationary items, Electronic-Electrical Components, Mechanical & Scientific goods as per the requirement of a particular model. Colour of product and decoration item may be varying according to availability of material but we make ensure that we will deliver the product with same working, structure and dimensions as describe in product description section.

---



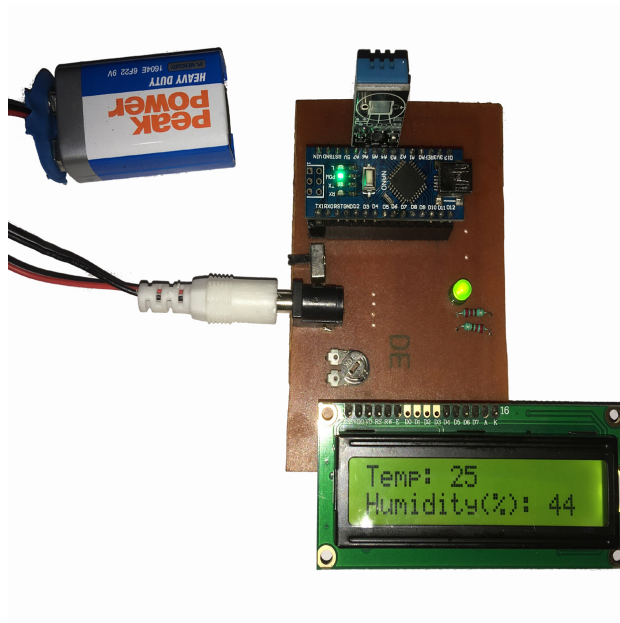

## Portable Temperature and Humidity Monitoring Device with LCD

### Available offers

- **Free Shipping** on orders above Rs999.
- Pay with UPI QR [Coupons](#)
- **Special Bulk Discount** for Companies and Institutions
- Get Special Discount Code: **9109087333**.

### Highlights

#### Branding Free Project

- No Brand Name/Logo on Projects
- 100% Working project
- Tested Project & Delivery

#### Documentation

- Free Project Synthesis
- Printed Short Report
- Printable Soft copy

#### Support

- Demo Video – [English](#)
- Technical Support
- [Get Discount Code](#)

#### Delivery Time

- **Handling Period** : 1-2 Days
- **Transit Time** :3-5 Days (Approx.)
- **Delivery Time** : Handling Period + Transit Time (4-7 Days Approx.)

[Read More](#)

**SKU:** PH\_EP\_016

**Price:** ~~₹2,916.00~~ Original price was: ₹2,916.00.₹  
1,720.00Current price is: ₹1,720.00.

**Stock:** instock

**Categories:** [Arduino](#), [Engineering project](#), [Projects](#)

## Product Description

## Download Free Project Synopsis

## Working Video

This is a handmade complete working Models, Projects & Activity kits supported by rough study material to make a suitable projects report by the student. It is using Cardboard/Wooden base, Paper, Foam based board, stationary items, Electronic-Electrical Components, Mechanical & Scientific goods as per the requirement of a particular model. Colour of product and decoration item may be varying according to availability of material but we make ensure that we will deliver the product with same working, structure and dimensions as describe in product description section.

---

## Power AA Cell Shakti Battery



### Support

- Technical Support – WhatsApp@9109087333
- Get Discount Coupon – WhatsApp@9303254433

[Read More](#)

**SKU:** PH\_COM\_260

**Price:** ~~₹20.00~~ Original price was: ₹20.00, ₹10.00

Current price is: ₹10.00.

**Stock:** instock

**Categories:** [Basic Components](#), [Batteries & Power Source](#), [Components & Spares](#)

### Product Description

---