

Mobile Cont using Bluet



Available offer

- **Free Shipping**
orders above ₹
- Pay with UPI Q
Discount./ [Cou](#)
- **Special Bulk**
Companies an
- Get Special Dis
WhatsApp@91

Highlights

Branding Free Pr

- No Brand Nam
PCB & Projects
- 100% Working
- Tested Project

Documentation

- Free Project Sy
- Printed Short F
- Printable Soft

Support

- Demo Video –
- Technical Supp
- [Get Discount C](#)

[Read More](#)

SKU: PH_EP_071

Price:

Stock: instock

Categories: [Android / Smartphone Controlled](#), [Arduino](#), [Engineering project](#), [Projects](#)

Product Description

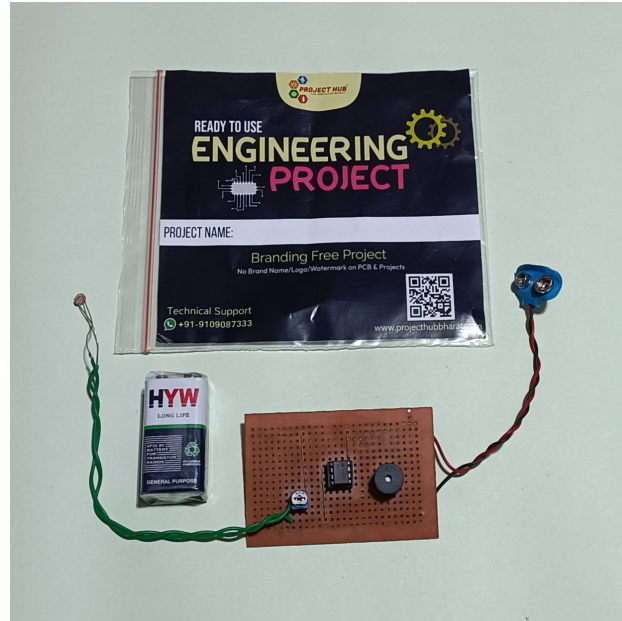

Morning Alarm Project Kit with Dotted/multicolored

Package Includes

Branding Free

- No Brand Name on PCB & Projects
- 100% Working
- Tested Project

Documentation

- Free Project System
- Printed instructions
- Printable Soft copy
- PPT

Support

- Demo Video –
- Technical Support
- Get Discount Code

[Read More](#)

SKU: PH_EP_088

Price: ₹372.00 Original price was: ₹372.00. ₹219.00
Current price is: ₹219.00.

Stock: instock

Categories: [Engineering project](#), [IC & Transistor](#), [Mini Project](#), [Projects](#)

Product Description

Download Free Project Synopsis

Working Video

This is a handmade complete working Models, Projects & Activity kits supported by rough study material to make a suitable projects report by the student. It is using Cardboard/Wooden base, Paper, Foam based board, stationary items, Electronic-Electrical Components, Mechanical & Scientific goods as per the requirement of a particular model. Colour of product and decoration item may be varying according to availability of material but we make ensure that we will deliver the product with same working, structure and dimensions as describe in product description section.

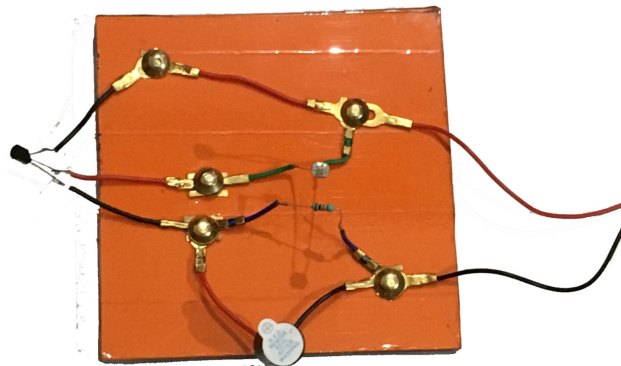

Morning Ala

Package Inc

Branding Free

- No Brand Nam
- PCB & Projects
- 100% Working
- Tested Project

Documentation

- Free Project Sy
- Printed instruc

Support

- Working Video – ***Embedded Below***
- Technical Support – WhatsApp@9109087333
- Get Discount Coupon - WhatsApp@9303254433

[Read More](#)

SKU: PH_SPK_010

Price: ~~₹320.00~~ Original price was: ₹320.00. ₹280.00
Current price is: ₹280.00.

Stock: instock

Categories: [Hobby DIY kits](#), [Science Project kit \(SPK\)](#)

Product Description

Download Free Project Synopsis

Working Video

This is a handmade complete working Models, Projects & Activity kits supported by rough study material to make a suitable projects report by the student. It is using Cardboard/Wooden base, Paper, Foam based board, stationary items, Electronic-Electrical Components, Mechanical & Scientific goods as per the requirement of a particular model. Colour of product and decoration item may be varying according to availability of material but we make ensure that we will deliver the product with same working, structure and dimensions as describe in product description section.

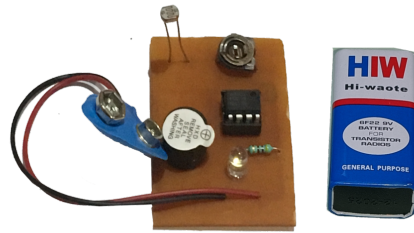

Morning Alarm PCB

Available offer

- **Free Shipping** above Rs999.
- COD available in above 999.
- Pay with UPI QR [Coupons](#)
- **Special Bulk D** Companies and
- Get Special Disc

Highlights

Branding Free Pr

- No Brand Name/ Projects
- 100% Working p
- Tested Project &

Documentation

- Free Project Syn
- Printed Short Re
- Printable Soft co

Support

- Demo Video – **En**
- Technical Suppo
- [Get Discount Co](#)

Click Here to Buy D

[Read More](#)

SKU: PH_EP_021

Price: ~~₹392.00~~ Original price was: ₹392.00. ₹231.00
Current price is: ₹231.00.

Stock: instock

Categories: [Engineering project](#), [IC & Transistor](#), [Mini Project](#), [Projects](#)

Product Description

ABSTRACT:

Waking up in the morning is quite a task for many people. The aim of this project is to build an alarm clock which will help people go get up a little bit easier. Additionally if one forgets to set alarm at night, this alarm will turn on automatically in the morning and only turn off manually so you will have to wake up.

INTRODUCTION:

The Morning Alarm project aims to create a simple and effective alarm system using components such as an LDR (Light Dependent Resistor), IC 555 Timer, 9V Battery, Buzzer, LED, and a 100K preset resistor. This project serves as an alarm clock that can be used to wake up individuals at a desired time. By utilizing light sensing capabilities, the alarm can be triggered based on the ambient light conditions, simulating a natural sunrise effect.

[Download Free Project Synopsis](#)

Working Video

Disclaimer:

This is a handmade complete working Models, Projects & Activity kits supported by rough study material to make a suitable projects report by the student. It is using Cardboard/Wooden base, Paper, Foam based board, stationary items, Electronic-Electrical Components, Mechanical & Scientific goods as per the requirement of a particular model. Colour of product and decoration item may be varying according to availability of material but we make ensure that we will deliver the product with same working, structure and dimensions as describe in product description section.



Morning Ala

Available offer

- **Free Shipping** above Rs999.
- Pay with UPI QR [Coupons](#)
- **Special Bulk D** Companies and
- Get Special Dis 9109087333.

Highlights

Branding Free Pr

- No Brand Name/ Projects
- 100% Working p
- Tested Project &

Documentation

- Free Project Syn
- Printed Short Re
- Printable Soft co

Support

- Demo Video – **En**
- Technical Suppo
- [Get Discount Co](#)

Delivery Time

- **Handling Period**
- **Transit Time :3**

- **Delivery Time** : Handling Period + Transit Time (4-7 Days Approx.)

[Read More](#)

SKU: PH_EP_129

Price: ~~₹236.00~~ Original price was: ₹236.00. ₹139.00
Current price is: ₹139.00.

Stock: instock

Categories: [Engineering project](#), [IC & Transistor](#), [Mini Project](#), [Projects](#)

Product Description

[Download Free Project Synopsis](#)

[Working Video:](#)

Disclaimer:

This is a handmade complete working Models, Projects & Activity kits supported by rough study material to make a suitable projects report by the student. It is using Cardboard/Wooden base, Paper, Foam based board, stationary items, Electronic-Electrical Components, Mechanical & Scientific goods as per the requirement of a particular model. Colour of product and decoration item may be varying according to availability of material but we make ensure that we will deliver the product with same working, structure and dimensions as describe in product description section.

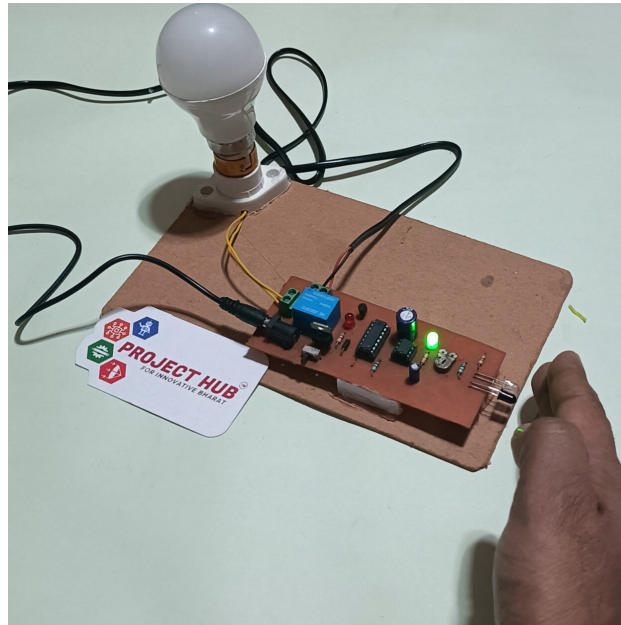

Motion Sensor

Available offer

- **Free Shipping** above Rs999.
- Pay with UPI QR [Coupons](#)
- **Special Bulk Discount** for Companies and Institutions
- Get Special Discount on Bulk Orders

Highlights

Branding Free Project

- No Brand Name/Logo on Projects
- 100% Working project
- Tested Project & Components

Documentation

- Free Project Synthesis
- Printed Short Report
- Printable Soft copy

Support

- Demo Video - [English](#)
- Technical Support
- [Get Discount Coupon](#)

Click Here to Buy Digital Bundle Click Here to Buy Digital Bundle

- Printable Soft copy
- Printable Soft copy

[Read More](#)

SKU: PH_EP_035

Price: ~~₹1,228.00~~ Original price was: ₹1,228.00. ₹725.00 Current price is: ₹725.00.

Stock: instock

Categories: [Engineering project](#), [IC & Transistor](#), [Projects](#)

Product Description

Disclaimer:

This is a handmade complete working Models, Projects & Activity kits supported by rough study material to make a suitable projects report by the student. It is using Cardboard/Wooden base, Paper, Foam based board, stationary items, Electronic-Electrical Components, Mechanical & Scientific goods as per the requirement of a particular model. Colour of product and decoration item may be varying according to availability of material but we make ensure that we will deliver the product with same working, structure and dimensions as describe in product description section.



Multitec 150b Wire Stripper and Cutter

[Read More](#)

SKU: PH_TI_015

Price: ~~₹100.00~~ Original price was: ₹100.00. ₹60.00 Current price is: ₹60.00.

Stock: instock

Categories: [Electronic Lab](#), [Tools & Laboratory Instruments](#)

Product Description

This Multitec 150b Wire Stripper and Cutter is a High-grade alloy steel stripper/cutter ideal for professionals. The tool is suitable for the flush cutting action. The tool is mainly used to strip and cut the wire with a 12-24 gauge. The black oxide finish prevents corrosion. Based on the wire size, screws have to be adjusted.

Features :

1. An improved handle for extra comfort and grip.
2. Sharp cutting edge.
3. Suitable for industrial applications.
4. H-8mm L-13cm W-80 gm.
5. Fast cutting action with black oxide finish.
6. Strips and cuts wire 12-24 gauge.
7. Wire Gauge screw in slot holds stripping die to the proper size for repeated jobs and prevent nipped wire.
8. Sharp cutting edges for all industrial uses.

* Product Images are shown for illustrative purposes only and may differ from actual product.

Multitec 68 C Wire Cutter - Stripper

[Read More](#)

SKU: PH_TI_016

Price: ₹100.00 Original price was: ₹100.00. ₹60.00
Current price is: ₹60.00.

Stock: instock

Categories: [Electronic Lab](#), [Tools & Laboratory Instruments](#)



Product Description

It is a Multitec 68 C Wire Cutter Stripper that comes with spring and screw gauge adjuster with PVC cushioned grips. These are made up of high-quality material. This is best known as a hand tool, which can be tremendously used for stripping the electrical insulations from the electric

wires.

Features:

1. High-quality product
2. Suitable for all applications
3. Super finished sharp cutting edges
4. Spring and screw gauge adjuster
5. Handy equipment
6. Lightweight
7. Anti-Corrosive
8. Easy to use

* Product Images are shown for illustrative purposes only and may differ from actual product.

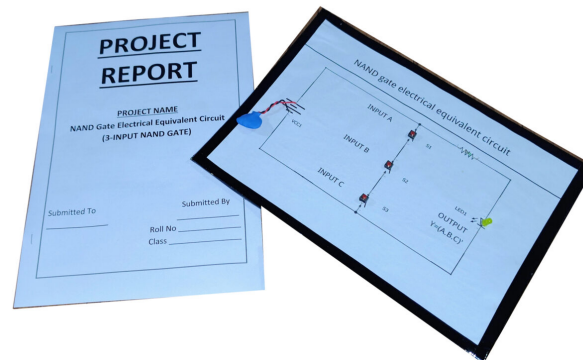

NAND logic equivalent circuit

Package Includes

Branding Free

- No Brand Name
- PCB & Projects
- Tested Activity

Documentation

- Free Project Sy
- Printed instruc

Support

- Working Video
- Technical Supp
- Get Discount C

[Read More](#)

SKU: PH_SPE_74

Price: ₹336.00 Original price was: ₹336.00. ~~₹198.00~~
Current price is: ₹198.00.

Stock: instock

Categories: [Electronics](#), [Logic Gate](#), [Physics](#), [Projects](#), [School Project & Experiment](#)

Tags: [class 12th science project and experiment](#), [logic gate](#), [new science project](#)

Product Description

Download Free Project Synopsis

Disclaimer

This is a handmade complete working Models, Projects & Activity kits supported by rough study material to make a suitable projects report by the student. It is using Cardboard/Wooden base, Paper, Foam based board, stationary items, Electronic-Electrical Components, Mechanical & Scientific goods as per the requirement of a particular model. Colour of product and decoration item may be varying according to availability of material but we make ensure that we will deliver the product with same working, structure and dimensions as describe in product description section.



NAND logic transistors

Package Includes

Branding Free

- No Brand Name
- PCB & Projects
- Tested Activity

Documentation

- Free Project Synopsis – **Embedded below**
- Printed instruction booklet

Support

- Working Video – **Embedded Below**
- Technical Support – WhatsApp@9109087333
- Get Discount Coupon – WhatsApp@9303254433

[Read More](#)

SKU: PH_SPE_76

Price: ~~₹368.00~~ Original price was: ₹368.00. ₹217.00
Current price is: ₹217.00.

Stock: instock

Categories: [Electronics](#), [Logic Gate](#), [Physics](#), [Projects](#), [School Project & Experiment](#)

Tags: [class 12th science project and experiment](#), [logic gate](#), [new science project](#)

Product Description

Download Free Project Synopsis

Disclaimer

This is a handmade complete working Models, Projects & Activity kits supported by rough study material to make a suitable projects report by the student. It is using Cardboard/Wooden base, Paper, Foam based board, stationary items, Electronic-Electrical Components, Mechanical & Scientific goods as per the requirement of a particular model. Colour of product and decoration item may be varying according to availability of material but we make ensure that we will deliver the product with same working, structure and dimensions as describe in product description section.



Newton color

Kit Includes:

- **Project Kit**
- **9V Battery**
- **Print Short R**

Available offers:

- **Free Shipping**
orders above ₹
- **Pay with UPI**
Discount./[Coupo](#)
- **Special Bulk**
Companies and
- **Get Special D**
WhatsApp@91

Highlights Brand

- No Brand Name
- PCB & Projects
- 100% Working
- Tested Project

Documentation

- Printed Short F
- Printable Soft

Support

- Demo Video –
- Technical Supp
- [Get Discount C](#)

[Read More](#)

SKU: PH_SPE_77

Price:

Stock: instock

Categories: [Electronics](#), [General science](#), [Physics](#), [Projects](#), [School Project & Experiment](#)

Product Description

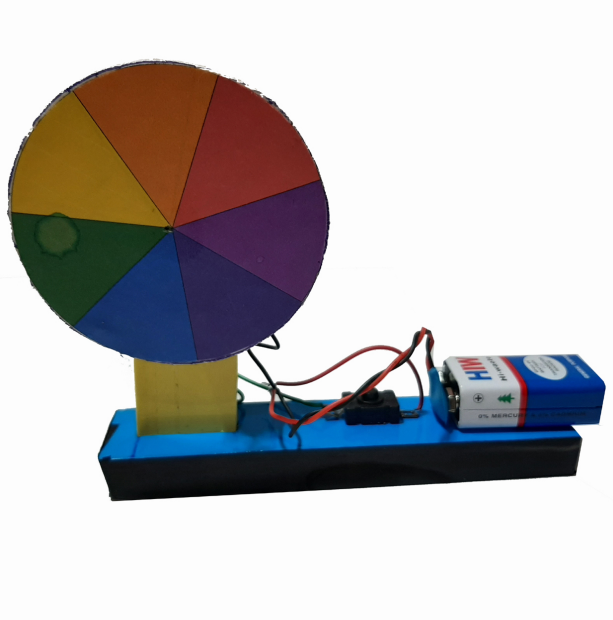

Newton's Disk (Motorized), Do It Yourself Kit

Package Includes:

Branding Free Project / Activity kit

- No Brand Name/Logo/Watermark on Components, PCB & Projects
- 100% Working project
- Tested Project & Activity kits

Documentation

- Free Project Synopsis – ***Embedded below***
- Printed instruction booklet

Support

- Working Video – ***Embedded Below***
- Technical Support – WhatsApp@9109087333
- Get Discount Coupon – WhatsApp@9303254433

[Read More](#)

SKU: PH_SPK_039

Price: ₹280.00 Original price was: ₹280.00. ₹240.00
Current price is: ₹240.00.

Stock: instock

Categories: [Hobby DIY kits](#), [Science Project kit \(SPK\)](#)

Product Description

- Printed Short Report
- Printable Soft copy of Project Report

Support

- Demo Video – **Embedded below**
- Technical Support – WhatsApp@9109087333
- [Get Discount Coupon](#)

[Read More](#)

SKU: PH_SPE_78

Price: ~~₹480.00~~ Original price was: ₹480.00. ₹283.00
Current price is: ₹283.00.

Stock: instock

Categories: [Electricity & Magnetism](#), [Electronics](#), [General science](#), [Physics](#), [Projects](#), [School Project & Experiment](#)

Product Description



Nitrogen Cy

Kit Includes:

- **Project Kit**
- **9V Battery**
- **Print Short R**

Available offers:

- **Free Shipping**
orders above ₹
- **Pay with UPI**
Discount./[Cou](#)
- **Special Bulk**
Companies an
- **Get Special D**
WhatsApp@91

Highlights Branding Free Project / Activity kit

- No Brand Name/Logo/Watermark on Components, PCB & Projects
- 100% Working project
- Tested Project & Activity kits

Documentation

- Printed Short Report
- Printable Soft copy of Project Report

Support

- Demo Video – **Embedded below**
- Technical Support – WhatsApp@9109087333
- [Get Discount Coupon](#)

[Read More](#)

SKU: PH_SPE_23

Price:

Stock: instock

Categories: [Biology](#), [General science](#), [Projects](#), [School Project & Experiment](#)

Product Description

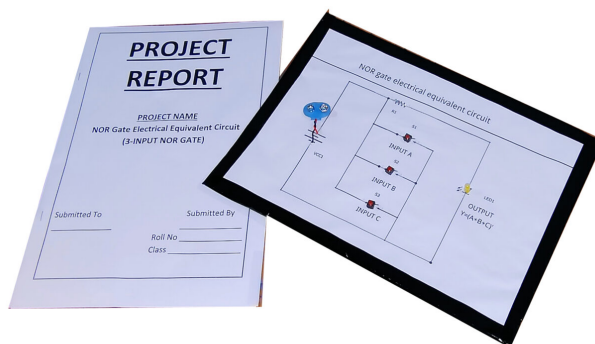

NOR logic g equivalent c

Package Includ

Branding Free

- No Brand Nam
PCB & Projects

- Tested Activity kits

Documentation

- Free Project Synopsis – **Embedded below**
- Printed instruction booklet

Support

- Working Video – **Embedded Below**
- Technical Support – WhatsApp@9109087333
- Get Discount Coupon – WhatsApp@9303254433

[Read More](#)

SKU: PH_SPE_79

Price: ~~₹336.00~~ Original price was: ₹336.00. ₹198.00
Current price is: ₹198.00.

Stock: instock

Categories: [Electronics](#), [Logic Gate](#), [Physics](#), [Projects](#), [School Project & Experiment](#)

Tags: [class 12th science project and experiment](#), [logic gate](#), [new science project](#)

Product Description

Download Free Project Synopsis

Disclaimer

This is a handmade complete working Models, Projects & Activity kits supported by rough study material to make a suitable projects report by the student. It is using Cardboard/Wooden base, Paper, Foam based board, stationary items, Electronic-Electrical Components, Mechanical & Scientific goods as per the requirement of a particular model. Colour of product and decoration item may be varying according to availability of material but we make ensure that we will deliver the product with same working, structure and dimensions as describe in product description section.

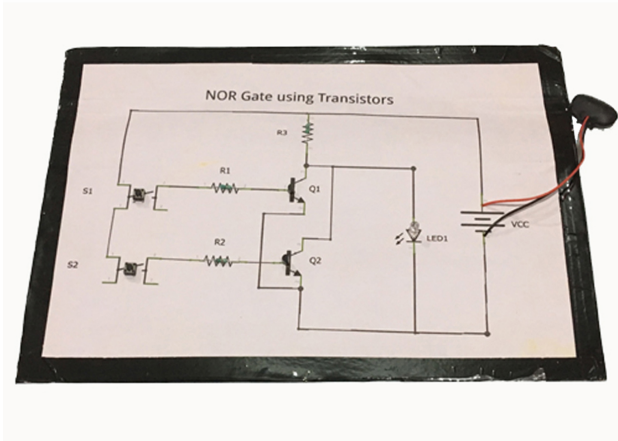

NOR logic gate using transistors

Package Includes:

Branding Free Activity kit

- No Brand Name/Logo/Watermark on Components, PCB & Projects
- Tested Activity kits

Documentation

- Free Project Synopsis – **Embedded below**
- Printed instruction booklet

Support

- Working Video – **Embedded Below**
- Technical Support – WhatsApp@9109087333
- Get Discount Coupon – WhatsApp@9303254433

[Read More](#)

SKU: PH_SPE_81

Price: ~~₹368.00~~ Original price was: ₹368.00. ₹217.00
Current price is: ₹217.00.

Stock: instock

Categories: [Electronics](#), [Logic Gate](#), [Physics](#), [Projects](#), [School Project & Experiment](#)

Tags: [class 12th science project and experiment](#), [logic gate](#), [new science project](#)

Product Description

Download Free Project Synopsis

Disclaimer

This is a handmade complete working Models, Projects & Activity kits supported by rough study material to make a suitable projects report by the student. It is using Cardboard/Wooden base, Paper, Foam based board, stationary items, Electronic-Electrical Components, Mechanical & Scientific goods as per the requirement of a particular model. Colour of product and decoration item may be varying according to availability of material but we make ensure that we will deliver the product with same working, structure and dimensions as describe in product description section.



NOT Gate u

Kit Includes:

- **Project Kit**
- **9V Battery**
- **Print Short R**

Available offers:

- **Free Shipping**
orders above ₹
- **Pay with UPI**
Discount./[Cou](#)
- **Special Bulk**
Companies an
- **Get Special D**
WhatsApp@91

Highlights Brand

- No Brand Nam
- PCB & Projects
- 100% Working
- Tested Project

Documentation

- Printed Short F
- Printable Soft

Support

- Demo Video – **Embedded below**
- Technical Support – WhatsApp@9109087333
- [Get Discount Coupon](#)

[Read More](#)

SKU: PH_SPE_83

Price:

Stock: instock

Categories: [Electronics](#), [General science](#), [Physics](#), [Projects](#), [School Project & Experiment](#)

Product Description



NOT Gate u

Kit Includes:

- **Project Kit**
- **9V Battery**
- **Print Short R**

Available offers:

- **Free Shipping**
orders above ₹
- **Pay with UPI**
Discount./[Cou](#)
- **Special Bulk**
Companies an
- **Get Special D**
WhatsApp@91

Highlights Brand

- No Brand Nam
- PCB & Projects
- 100% Working
- Tested Project

Documentation

- Printed Short Report
- Printable Soft copy of Project Report

Support

- Demo Video – **Embedded below**
- Technical Support – WhatsApp@9109087333
- [Get Discount Coupon](#)

[Read More](#)

SKU: PH_SPE_84

Price:

Stock: instock

Categories: [Electronics](#), [General science](#), [Physics](#), [Projects](#), [School Project & Experiment](#)

Product Description

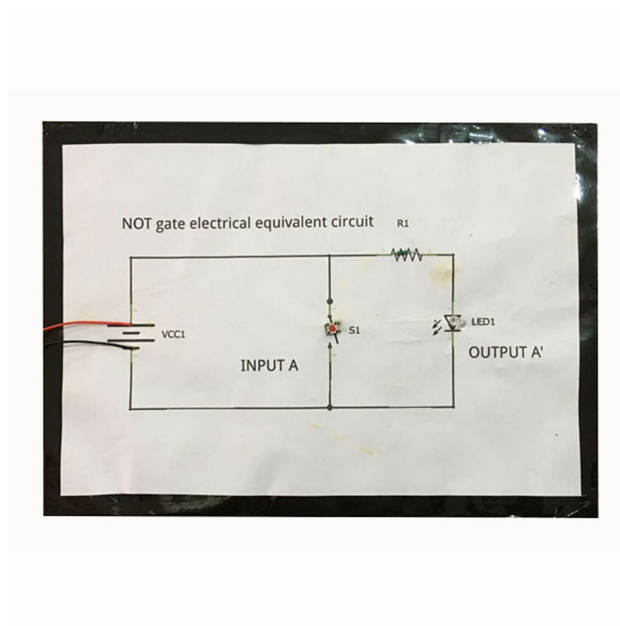

NOT logic gate equivalent circuit

Package Includes

Branding Free

- No Brand Name
- PCB & Projects
- Tested Activity

Documentation

- Free Project Sy
- Printed instruc

Support

- Working Video – **Embedded Below**
- Technical Support – WhatsApp@9109087333
- Get Discount Coupon - WhatsApp@9303254433

[Read More](#)

SKU: PH_SPE_82

Price: ~~₹320.00~~ Original price was: ₹320.00. ₹189.00
Current price is: ₹189.00.

Stock: instock

Categories: [Electronics](#), [Logic Gate](#), [Physics](#), [Projects](#), [School Project & Experiment](#)

Tags: [class 12th science project and experiment](#), [logic gate](#), [new science project](#)

Product Description

Download Free Project Synopsis

Disclaimer

This is a handmade complete working Models, Projects & Activity kits supported by rough study material to make a suitable projects report by the student. It is using Cardboard/Wooden base, Paper, Foam based board, stationary items, Electronic-Electrical Components, Mechanical & Scientific goods as per the requirement of a particular model. Colour of product and decoration item may be varying according to availability of material but we make ensure that we will deliver the product with same working, structure and dimensions as describe in product description section.

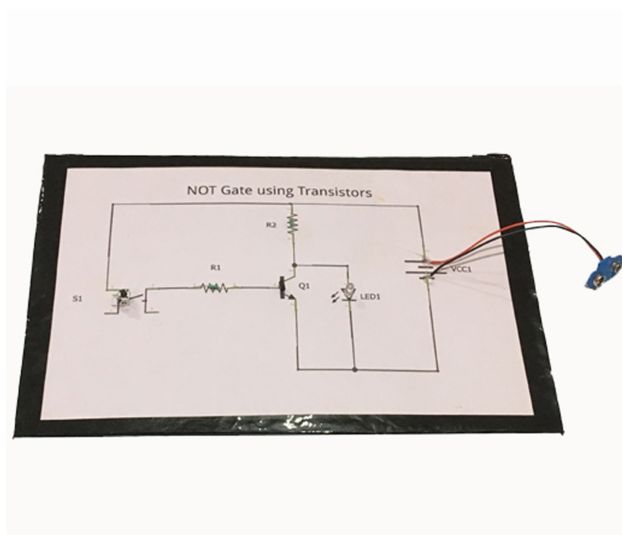

NOT logic gate using transistors

Package Includes:

Branding Free Activity kit

- No Brand Name/Logo/Watermark on Components, PCB & Projects
- Tested Activity kits

Documentation

- Free Project Synopsis – **Embedded below**
- Printed instruction booklet

Support

- Working Video – **Embedded Below**
- Technical Support – WhatsApp@9109087333
- Get Discount Coupon – WhatsApp@9303254433

[Read More](#)

SKU: PH_SPE_85

Price: ~~₹352.00~~ Original price was: ₹352.00. ₹208.00
Current price is: ₹208.00.

Stock: instock

Categories: [Electronics](#), [Logic Gate](#), [Physics](#), [Projects](#), [School Project & Experiment](#)

Tags: [class 12th science project and experiment](#), [logic gate](#), [new science project](#)

Product Description

Download Free Project Synopsis

Disclaimer

This is a handmade complete working Models, Projects & Activity kits supported by rough study material to make a suitable projects report by the student. It is using Cardboard/Wooden base, Paper, Foam based board, stationary items, Electronic-Electrical Components, Mechanical & Scientific goods as per the requirement of a particular model. Colour of product and decoration item may be varying according to availability of material but we make ensure that we will deliver the product with same working, structure and dimensions as describe in product description section.



Nuclear Fiss

Kit Includes:

- **Project Kit**
- **9V Battery**
- **Print Short R**

Available offers:

- **Free Shipping**
orders above ₹
- **Pay with UPI**
Discount./[Cou](#)
- **Special Bulk**
Companies an
- **Get Special D**
WhatsApp@91

Highlights Brand

- No Brand Nam
- PCB & Projects
- 100% Working
- Tested Project

Documentation

- Printed Short F
- Printable Soft

Support

- Demo Video – **Embedded below**
- Technical Support – WhatsApp@9109087333
- [Get Discount Coupon](#)

[Read More](#)

SKU: PH_SPE_116

Price:

Stock: instock

Categories: [Electronics](#), [General science](#), [Physics](#), [Projects](#), [School Project & Experiment](#)

Product Description



Nuclear Fusion

Kit Includes:

- **Project Kit**
- **9V Battery**
- **Print Short R**

Available offers:

- **Free Shipping**
orders above ₹
- **Pay with UPI**
Discount./[Cou](#)
- **Special Bulk**
Companies an
- **Get Special D**
WhatsApp@91

Highlights Brand

- No Brand Nam
- PCB & Projects
- 100% Working
- Tested Project

Documentation

- Printed Short Report
- Printable Soft copy of Project Report

Support

- Demo Video – **Embedded below**
- Technical Support – WhatsApp@9109087333
- [Get Discount Coupon](#)

[Read More](#)

SKU: PH_SPE_115

Price:

Stock: instock

Categories: [Electronics](#), [General science](#), [Physics](#), [Projects](#), [School Project & Experiment](#)

Product Description



Nuclear Fusion Fission

Kit Includes:

- **Project Kit**
- **9V Battery**
- **Print Short R**

Available offers:

- **Free Shipping** on orders above ₹
- **Pay with UPI** and get 5% Discount./[Cou](#)
- **Special Bulk** Discounts for Companies and

- **Get Special Discount Coupon** –
WhatsApp@9109087333.

Highlights Branding Free Project / Activity kit

- No Brand Name/Logo/Watermark on Components, PCB & Projects
- 100% Working project
- Tested Project & Activity kits

Documentation

- Printed Short Report
- Printable Soft copy of Project Report

Support

- Demo Video – **Embedded below**
- Technical Support – WhatsApp@9109087333
- [Get Discount Coupon](#)

[Read More](#)

SKU: PH_SPE_117

Price:

Stock: instock

Categories: [Electronics](#), [General science](#), [Physics](#), [Projects](#), [School Project & Experiment](#)

Product Description



Obstacle Avoidance Arduino & U

Available offer

- **Free Shipping**
orders above ₹
- Pay with UPI QR
Discount./ [Cou](#)
- **Special Bulk**
Companies and
- Get Special Dis
WhatsApp@91

Highlights

Branding Free Pr

- No Brand Name
PCB & Projects
- 100% Working
- Tested Project

Documentation

- Free Project Sy
- Printed Short P
- Printable Soft

Support

- Demo Video –
- Technical Supp
- [Get Discount C](#)

Delivery Time

- **Handling Period** : 1-2 Days
- **Transit Time** :3-5 Days (Approx.)
- **Delivery Time** : Handling Period + Transit Time (4-7 Days Approx.)

Click Here to Buy Do It Yourself Kit

[Read More](#)

SKU: PH_EP_105

Price:

Stock: instock

Categories: [Arduino](#), [Engineering project](#), [Mechanical](#), [Projects](#), [Robotics](#)

Product Description

Download Free Project Synopsis

Working Video

Disclaimer:

This is a handmade complete working Models, Projects & Activity kits supported by rough study material to make a suitable projects report by the student. It is using Cardboard/Wooden base, Paper, Foam based board, stationary items, Electronic-Electrical Components, Mechanical & Scientific goods as per the requirement of a particular model. Colour of product and decoration item may be varying according to availability of material but we make ensure that we will deliver the product with same working, structure and dimensions as describe in product description section.
