

Household Circuit Model

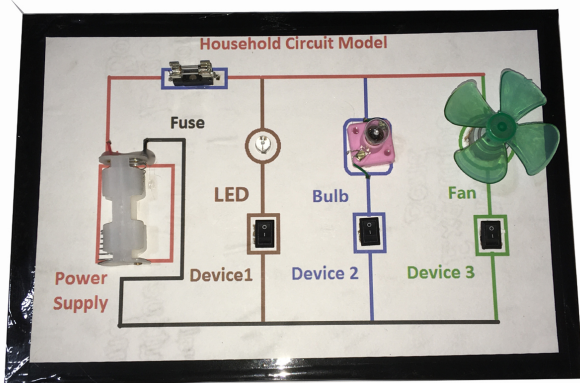

Package Includes:

Branding Free Activity kit

- No Brand Name/Logo/Watermark on Components, PCB & Projects
- Tested Activity kits

Documentation

- Free Project Synopsis – **Embedded below**
- Printed instruction booklet

Support

- Working Video – **Embedded Below**
- Technical Support – WhatsApp@9109087333
- Get Discount Coupon – WhatsApp@9303254433

[Read More](#)

SKU: PH_SPE_61

Price: ~~₹680.00~~ Original price was: ₹680.00. ₹401.00

Current price is: ₹401.00.

Stock: instock

Categories: [Electricity & Magnetism](#), [Physics](#), [Projects](#), [School Project & Experiment](#)

Tags: [class 12th science project and experiment](#), [new science project](#)

Product Description

Download Free Project Synopsis

Disclaimer

This is a handmade complete working Models, Projects & Activity kits supported by rough study material to make a suitable projects report by the student. It is using Cardboard/Wooden base, Paper, Foam based board, stationary items, Electronic-Electrical Components, Mechanical & Scientific goods as per the requirement of a particular model. Colour of product and decoration item may be varying according to availability of material but we make ensure that we will deliver the product with same working, structure and dimensions as describe in product description section.

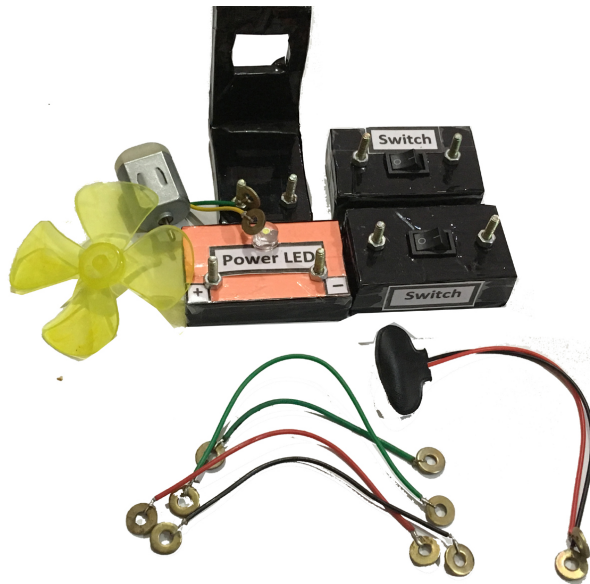

Household Component

Package Inc

Branding Free

- No Brand Name
- PCB & Projects
- 100% Working
- Tested Project

Documentation

- Free Project Sy
- Printed instruc

Support

- Working Video
- Technical Supp
- Get Discount C

[Read More](#)

SKU: PH_SPK_003

Price: ₹320.00 Orig
Current price is: ₹2

Stock: instock

Categories: [Hobby DIY kits](#), [Science Project kit \(SPK\)](#)

Product Description

Download Free Project Synopsis

Working Video

This is a handmade complete working Models, Projects & Activity kits supported by rough study material to make a suitable projects report by the student. It is using Cardboard/Wooden base, Paper, Foam based board, stationary items, Electronic-Electrical Components, Mechanical & Scientific goods as per the requirement of a particular model. Colour of product and decoration item may be varying according to availability of material but we make ensure that we will deliver the product with same working, structure and dimensions as describe in product description section.

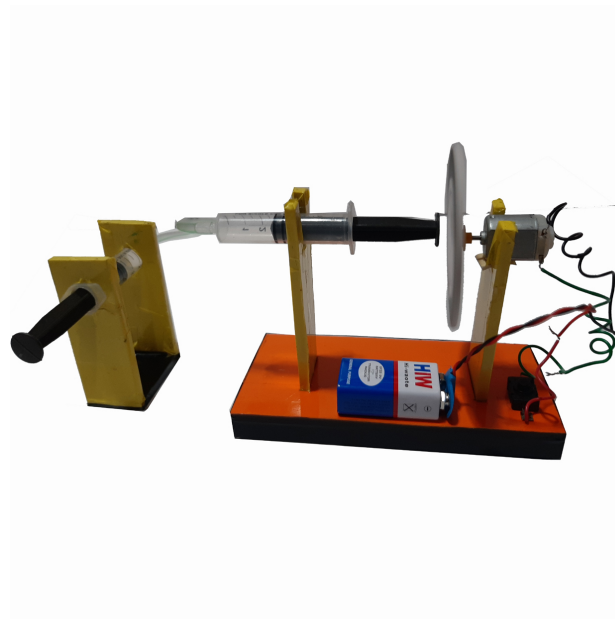

Hydraulic B Pascals Law

Package Inc

Branding Free

- No Brand Name
- PCB & Projects
- 100% Working
- Tested Project

Documentation

- Free Project Sy
- Printed instruc

Support

- Working Video

- Technical Support – WhatsApp@9109087333
- Get Discount Coupon - WhatsApp@9303254433

[Read More](#)

SKU: PH_SPK_041

Price: ₹440.00 Original price was: ₹440.00. ~~₹399.00~~
Current price is: ₹399.00.

Stock: instock

Categories: [Hobby DIY kits](#), [Science Project kit \(SPK\)](#)

Product Description

Download Free Project Synopsis

Working Video

This is a handmade complete working Models, Projects & Activity kits supported by rough study material to make a suitable projects report by the student. It is using Cardboard/Wooden base, Paper, Foam based board, stationary items, Electronic-Electrical Components, Mechanical & Scientific goods as per the requirement of a particular model. Colour of product and decoration item may be varying according to availability of material but we make ensure that we will deliver the product with same working, structure and dimensions as describe in product description section.

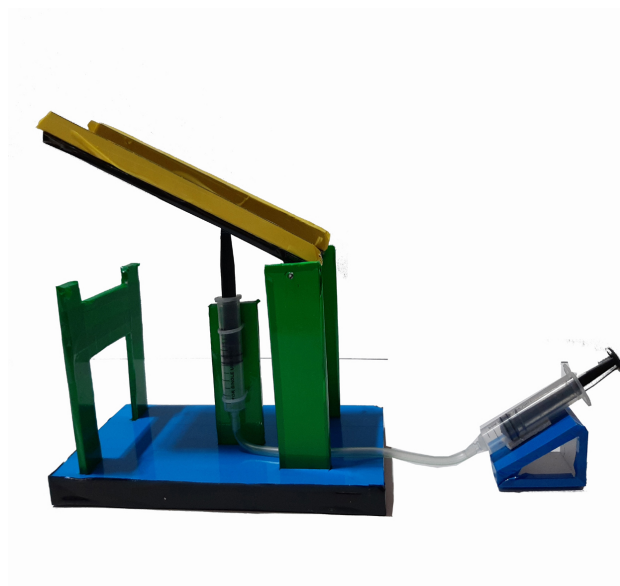

**Hydraulic B
based Activ**

Package Inc

Branding Free

- No Brand Name
- PCB & Projects
- 100% Working
- Tested Project

Documentation

- Free Project Synopsis – ***Embedded below***
- Printed instruction booklet

Support

- Working Video – ***Embedded Below***
- Technical Support – WhatsApp@9109087333
- Get Discount Coupon – WhatsApp@9303254433

[Read More](#)

SKU: PH_SPK_013

Price: ~~₹400.00~~ Original price was: ₹400.00. ₹360.00
Current price is: ₹360.00.

Stock: instock

Categories: [Hobby DIY kits](#), [Science Project kit \(SPK\)](#)

Product Description

Download Free Project Synopsis

Working Video

This is a handmade complete working Models, Projects & Activity kits supported by rough study material to make a suitable projects report by the student. It is using Cardboard/Wooden base, Paper, Foam based board, stationary items, Electronic-Electrical Components, Mechanical & Scientific goods as per the requirement of a particular model. Colour of product and decoration item may be varying according to availability of material but we make ensure that we will deliver the product with same working, structure and dimensions as describe in product description section.



Hydraulic Crane, Do It Yourself Kit

Package Includes:

Branding Free Project / Activity kit

- No Brand Name/Logo/Watermark on Components, PCB & Projects
- 100% Working project
- Tested Project & Activity kits

Documentation

- Free Project Synopsis – ***Embedded below***
- Printed instruction booklet

Support

- Working Video – ***Embedded Below***
- Technical Support – WhatsApp@9109087333
- Get Discount Coupon – WhatsApp@9303254433

[Read More](#)

SKU: PH_SPK_058

Price: ~~₹320.00~~ Original price was: ₹320.00. ₹280.00
Current price is: ₹280.00.

Stock: instock

Categories: [Hobby DIY kits](#), [HYDRAULIC](#), [Science Project kit \(SPK\)](#)

Product Description

Download Free Project Synopsis

Working Video

This is a handmade complete working Models, Projects & Activity kits supported by rough study material to make a suitable projects report by the student. It is using Cardboard/Wooden base, Paper, Foam based board, stationary items, Electronic-Electrical Components, Mechanical & Scientific goods as per the requirement of a particular model. Colour of product and decoration item may be varying according to availability of material but we make ensure that we will deliver the product with same working, structure and dimensions as describe in product description section.

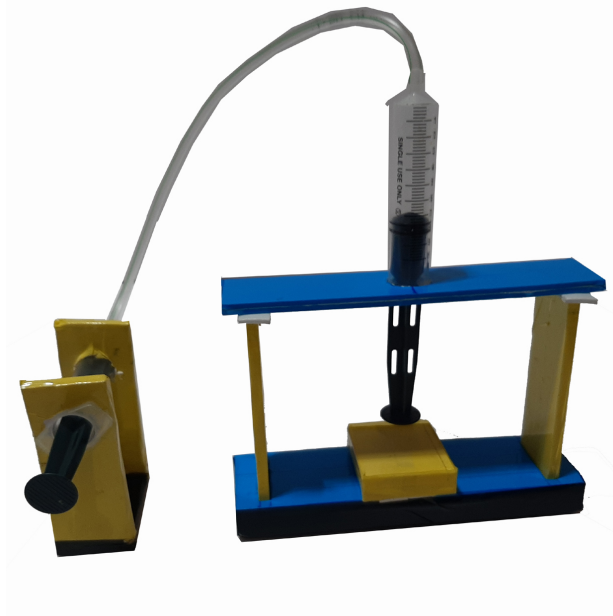

Hydraulic Press, Pascals Law DIY Project kit

Package Includes:

Branding Free Project / Activity kit

- No Brand Name/Logo/Watermark on Components, PCB & Projects
- 100% Working project
- Tested Project & Activity kits

Documentation

- Free Project Synopsis – ***Embedded below***
- Printed instruction booklet

Support

- Working Video – ***Embedded Below***
- Technical Support – WhatsApp@9109087333
- Get Discount Coupon – WhatsApp@9303254433

[Read More](#)

SKU: PH_SPK_042

Price: ~~₹320.00~~ Original price was: ₹320.00. ₹280.00
Current price is: ₹280.00.

Stock: instock

Categories: [Hobby DIY kits](#), [Science Project kit \(SPK\)](#)

Product Description

Download Free Project Synopsis

Working Video

This is a handmade complete working Models, Projects & Activity kits supported by rough study material to make a suitable projects report by the student. It is using Cardboard/Wooden base, Paper, Foam based board, stationary items, Electronic-Electrical Components, Mechanical & Scientific goods as per the requirement of a particular model. Colour of product and decoration item may be varying according to availability of material but we make ensure that we will deliver the product with same working, structure and dimensions as describe in product description section.



Hydraulic R Yourself Kit

Package Inc

Branding Free

- No Brand Name
- PCB & Projects
- 100% Working
- Tested Project

Documentation

- Free Project Sy
- Printed instruc

Support

- Working Video
- Technical Supp
- Get Discount C

[Read More](#)

SKU: PH_SPK_059

Price:

Stock: instock

Categories: [Hobby DIY kits](#), [HYDRAULIC](#), [Science Project kit \(SPK\)](#)

Product Description

Download Free Project Synopsis

Working Video

This is a handmade complete working Models, Projects & Activity kits supported by rough study material to make a suitable projects report by the student. It is using Cardboard/Wooden base, Paper, Foam based board, stationary items, Electronic-Electrical Components, Mechanical & Scientific goods as per the requirement of a particular model. Colour of product and decoration item may be varying according to availability of material but we make ensure that we will deliver the product with same working, structure and dimensions as describe in product description section.



Identification

Electronic C

Kit Includes:

- **Project Kit**
- **9V Battery**
- **Print Short R**

Available offers:

- **Free Shipping** orders above F
- **Pay with UPI** Discount./[Coup](#)

- **Special Bulk Discounts** – for colleges, Schools, Companies and resellers. /[Contact Us](#).
- **Get Special Discount Coupon** – WhatsApp@9109087333.

Highlights **Branding Free Project / Activity kit**

- No Brand Name/Logo/Watermark on Components, PCB & Projects
- 100% Working project
- Tested Project & Activity kits

Documentation

- Printed Short Report
- Printable Soft copy of Project Report

Support

- Demo Video – **Embedded below**
- Technical Support – WhatsApp@9109087333
- [Get Discount Coupon](#)

[Read More](#)

SKU: PH_SPE_62

Price: ~~₹636.00~~ Original price was: ₹636.00. ₹375.00
Current price is: ₹375.00.

Stock: instock

Categories: [Electronics](#), [General science](#), [Physics](#), [Projects](#), [School Project & Experiment](#)

Product Description



Identification parts of an seed

Kit Includes:

- **Project Kit**
- **9V Battery**
- **Print Short R**

Available offers:

- **Free Shipping**
orders above ₹
- **Pay with UPI**
Discount./[Cou](#)
- **Special Bulk**
Companies an
- **Get Special D**
WhatsApp@91

Highlights Brand

- No Brand Name
PCB & Projects
- 100% Working
- Tested Project

Documentation

- Printed Short P
- Printable Soft c

Support

- Demo Video –
- Technical Supp
- [Get Discount C](#)

[Read More](#)

SKU: PH_SPE_48

Price:

Stock: instock

Categories: [Electronics](#), [General science](#), [Physics](#), [Projects](#), [School Project & Experiment](#)

Product Description



Infinite image project

Package Includes

Branding Free

- No Brand Name
- PCB & Projects
- 100% Working
- Tested Project

Documentation

- Free Project Sy
- Printed instruc

Support

- Working Video
- Technical Supp
- Get Discount C

[Read More](#)

SKU: PH_SPK_043

Price: ₹200.00 Original
Current price is: ₹1

Stock: instock

Categories: [Hobby DIY kits](#), [Science Project kit \(SPK\)](#)

Product Description

Download Free Project Synopsis

Working Video

This is a handmade complete working Models, Projects & Activity kits supported by rough study material to make a suitable projects report by the student. It is using Cardboard/Wooden base, Paper, Foam based board, stationary items, Electronic-Electrical Components, Mechanical & Scientific goods as per the requirement of a particular model. Colour of product and decoration item may be varying according to availability of material but we make ensure that we will deliver the product with same working, structure and dimensions as describe in product description section.



Intelligent C Detector cu regulator of & LCD

Available offer

- **Free Shipping**
orders above ₹
- Pay with UPI Q
Discount./ [Cou](#)
- **Special Bulk**
Companies an
- Get Special Dis
WhatsApp@91

Highlights

Branding Free Project / Activity kit

- No Brand Name/Logo/Watermark on Components, PCB & Projects
- 100% Working project
- Tested Project & Activity kits

Documentation

- Free Project Synopsis – **Embedded below**
- Printed Short Report
- Printable Soft copy of Project Report

Support

- Demo Video – **Embedded below**
- Technical Support – WhatsApp@9109087333
- [Get Discount Coupon](#)

[Read More](#)

SKU: PH_EP_054

Price:

Stock: instock

Categories: [Arduino](#), [Engineering project](#), [Projects](#)

Product Description

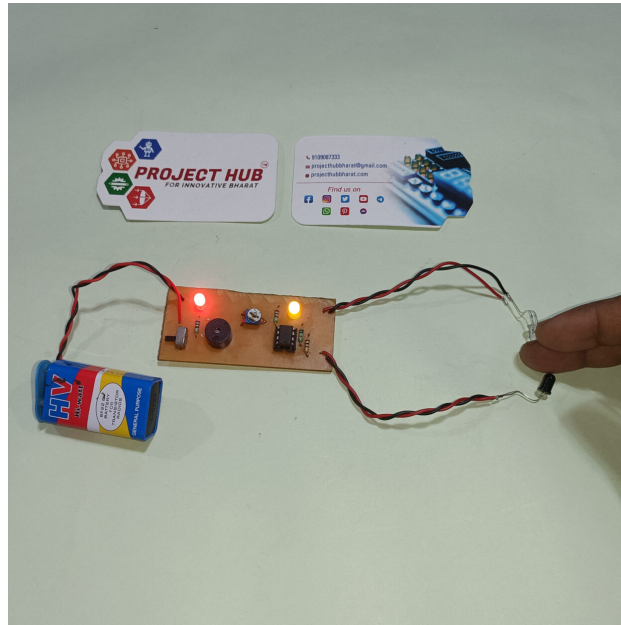

Invisible Bu

Available offer

- **Free Shipping** above Rs999.
- Pay with UPI QR [Coupons](#)
- **Special Bulk D** Companies and
- Get Special Disc

Highlights

Branding Free Pr

- No Brand Name/ Projects
- 100% Working p
- Tested Project &

Documentation

- Free Project Syn
- Printed Short Re
- Printable Soft co

Support

- Demo Video – **En**
- Technical Suppo
- [Get Discount Co](#)

[Read More](#)

SKU: PH_EP_085

Price: ₹436.00 Orig
Current price is: ₹2

Stock: instock

Categories: [Engineering project](#), [IC & Transistor](#), [Mini Project](#), [Projects](#)

Product Description

Download Free Project Synopsis

Working Video

Disclaimer:

This is a handmade complete working Models, Projects & Activity kits supported by rough study material to make a suitable projects report by the student. It is using Cardboard/Wooden base, Paper, Foam based board, stationary items, Electronic-Electrical Components, Mechanical & Scientific goods as per the requirement of a particular model. Colour of product and decoration item may be varying according to availability of material but we make ensure that we will deliver the product with same working, structure and dimensions as describe in product description section.



Ionic bond i

Kit Includes:

- **Project Kit**
- **9V Battery**
- **Print Short R**

Available offers:

- **Free Shipping**
orders above ₹
- **Pay with UPI**
Discount./[Coup](#)
- **Special Bulk**
Companies an

- **Get Special Discount Coupon** –
WhatsApp@9109087333.

Highlights Branding Free Project / Activity kit

- No Brand Name/Logo/Watermark on Components, PCB & Projects
- 100% Working project
- Tested Project & Activity kits

Documentation

- Printed Short Report
- Printable Soft copy of Project Report

Support

- Demo Video – **Embedded below**
- Technical Support – WhatsApp@9109087333
- [Get Discount Coupon](#)

[Read More](#)

SKU: PH_SPE_28

Price:

Stock: instock

Categories: [Chemistry](#), [Projects](#), [School Project & Experiment](#)

Product Description

IOT based Fire Alert System



Available offer

- **Free Shipping**
orders above ₹
- Pay with UPI Q
Discount./ [Cou](#)
- **Special Bulk**
Companies an
- Get Special Dis
WhatsApp@91

Highlights

Branding Free Pr

- No Brand Nam
PCB & Projects
- 100% Working
- Tested Project

Documentation

- Free Project Sy
- Printed Short P
- Printable Soft

Support

- Demo Video –
- Technical Supp
- [Get Discount C](#)

[Read More](#)

SKU: PH_EP_075

Price:

Stock: instock

Categories: [Engineering project](#), [IOT](#), [NodeMCU](#), [Projects](#)

Product Description



IOT based f using Node

Available offer

- **Free Shipping**
orders above ₹
- Pay with UPI Q
Discount./ [Cou](#)
- **Special Bulk**
Companies an
- Get Special Dis
WhatsApp@91

Highlights

Branding Free Pr

- No Brand Nam
PCB & Projects
- 100% Working
- Tested Project

Documentation

- Free Project Sy
- Printed Short F
- Printable Soft

Support

- Demo Video – **Embedded below**
- Technical Support – WhatsApp@9109087333
- [Get Discount Coupon](#)

Delivery Time

- **Handling Period** : 1-2 Days
- **Transit Time** :3-5 Days (Approx.)
- **Delivery Time** : Handling Period + Transit Time (4-7 Days Approx.)

Click Here to Buy Do It Yourself Kit

[Read More](#)

SKU: PH_EP_111

Price:

Stock: instock

Categories: [Engineering project](#), [Mechanical](#), [Projects](#), [Robotics](#)

Product Description

Download Free Project Synopsis

Working Video

Disclaimer:

This is a handmade complete working Models, Projects & Activity kits supported by rough study material to make a suitable projects report by the student. It is using Cardboard/Wooden base, Paper, Foam based board, stationary items, Electronic-Electrical Components, Mechanical & Scientific goods as per the requirement of a particular model. Colour of product and decoration item may be varying according to availability of material but we make ensure that we will deliver the product with same working, structure and dimensions as describe in product description section.



IOT based S system usin DHT11 Sens

Available offer

- **Free Shipping**
orders above ₹
- Pay with UPI Q
Discount./ [Cou](#)
- **Special Bulk**
Companies an
- Get Special Dis
WhatsApp@91

Highlights

Branding Free Pr

- No Brand Nam
PCB & Projects
- 100% Working
- Tested Project

Documentation

- Free Project Sy
- Printed Short F
- Printable Soft

Support

- Demo Video –
- Technical Supp
- [Get Discount C](#)

[Read More](#)

SKU: PH_EP_074

Price:

Stock: instock

Categories: [Engineering project](#), [IOT](#), [NodeMCU](#), [Projects](#)

Product Description



IOT based V

Available offer

- **Free Shipping**
orders above ₹
- Pay with UPI Q
Discount./ [Cou](#)
- **Special Bulk**
Companies an
- Get Special Dis
WhatsApp@91

Highlights

Branding Free Pr

- No Brand Nam
PCB & Projects
- 100% Working
- Tested Project

Documentation

- Free Project Sy
- Printed Short F
- Printable Soft

Support

- Demo Video – **Embedded below**
- Technical Support – WhatsApp@9109087333
- [Get Discount Coupon](#)

Delivery Time

- **Handling Period** : 1-2 Days
- **Transit Time** :3-5 Days (Approx.)
- **Delivery Time** : Handling Period + Transit Time (4-7 Days Approx.)

Click Here to Buy Do It Yourself Kit

[Read More](#)

SKU: PH_EP_110

Price:

Stock: instock

Categories: [Engineering project](#), [Mechanical](#), [Projects](#), [Robotics](#)

Product Description

Download Free Project Synopsis

Working Video

Disclaimer:

This is a handmade complete working Models, Projects & Activity kits supported by rough study material to make a suitable projects report by the student. It is using Cardboard/Wooden base, Paper, Foam based board, stationary items, Electronic-Electrical Components, Mechanical & Scientific goods as per the requirement of a particular model. Colour of product and decoration item may be varying according to availability of material but we make ensure that we will deliver the product with same working, structure and dimensions as describe in product description section.

Kirchoff's law of current (KCL)

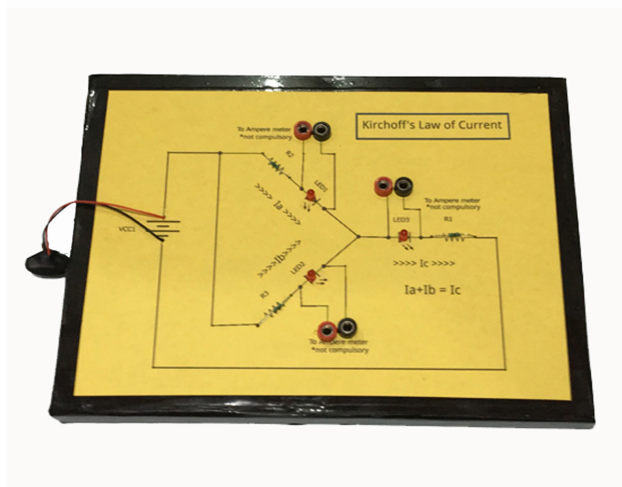

Package Includes:

Branding Free Activity kit

- No Brand Name/Logo/Watermark on Components, PCB & Projects
- Tested Activity kits

Documentation

- Free Project Synopsis – **Embedded below**
- Printed instruction booklet

Support

- Working Video – **Embedded Below**
- Technical Support – WhatsApp@9109087333
- Get Discount Coupon - WhatsApp@9303254433

[Read More](#)

SKU: PH_SPE_64

Price: ~~₹744.00~~ Original price was: ₹744.00. ₹439.00
Current price is: ₹439.00.

Stock: instock

Categories: [Electricity & Magnetism](#), [Physics](#), [Projects](#), [School Project & Experiment](#)

Tags: [class 12th science project and experiment](#), [new science project](#)

Product Description

Download Free Project Synopsis

Disclaimer

This is a handmade complete working Models, Projects & Activity kits supported by rough study material to make a suitable projects report by the student. It is using Cardboard/Wooden base, Paper, Foam based board, stationary items, Electronic-Electrical Components, Mechanical & Scientific goods as per the requirement of a particular model. Colour of product and decoration item may be varying according to availability of material but we make ensure that we will deliver the product with same working, structure and dimensions as describe in product description section.

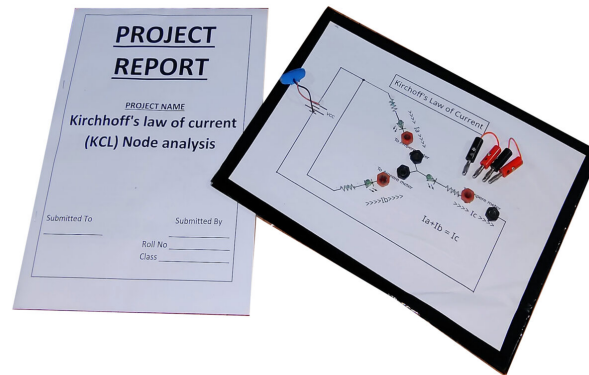

Kirchoff's law Node analysis

Package Includes

Branding Free

- No Brand Name
- PCB & Projects
- Tested Activity

Documentation

- Free Project Sy
- Printed instruc

Support

- Working Video
- Technical Supp
- Get Discount C

[Read More](#)

SKU: PH_SPE_65

Price: ₹496.00 Orig
Current price is: ₹2

Stock: instock

Categories: [Electr](#)
, [School Project & E](#)

Tags: [class 12th science project and experiment](#), [new science project](#)

Product Description

Download Free Project Synopsis

Disclaimer

This is a handmade complete working Models, Projects & Activity kits supported by rough study material to make a suitable projects report by the student. It is using Cardboard/Wooden base, Paper, Foam based board, stationary items, Electronic-Electrical Components, Mechanical & Scientific goods as per the requirement of a particular model. Colour of product and decoration item may be varying according to availability of material but we make ensure that we will deliver the product with same working, structure and dimensions as describe in product description section.



Kirchoff's la

Package Includ

Branding Free

- No Brand Name
- PCB & Projects
- Tested Activity

Documentation

- Free Project Sy
- Printed instruo

Support

- Working Video
- Technical Supp
- Get Discount C

[Read More](#)

SKU: PH_SPE_66

Price: ₹632.00 Original price was: ₹632.00. ~~₹373.00~~

Current price is: ₹373.00.

Stock: instock

Categories: [Electricity & Magnetism](#), [Physics](#), [Projects](#), [School Project & Experiment](#)

Tags: [class 12th science project and experiment](#), [new science project](#)

Product Description

Download Free Project Synopsis

Disclaimer

This is a handmade complete working Models, Projects & Activity kits supported by rough study material to make a suitable projects report by the student. It is using Cardboard/Wooden base, Paper, Foam based board, stationary items, Electronic-Electrical Components, Mechanical & Scientific goods as per the requirement of a particular model. Colour of product and decoration item may be varying according to availability of material but we make ensure that we will deliver the product with same working, structure and dimensions as describe in product description section.

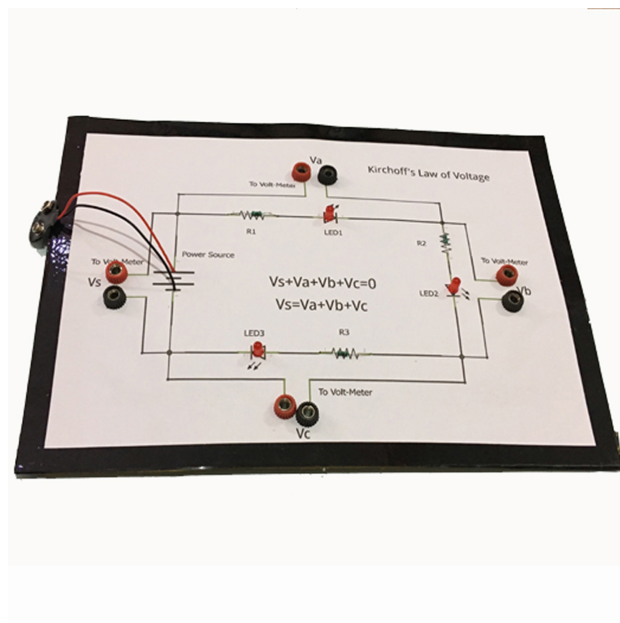

Kirchoff's Law of Voltage

Mesh analysis

Package Includes

Branding Free

- No Brand Name
- PCB & Projects
- Tested Activity

Documentation

- Free Project Synopsis – **Embedded below**
- Printed instruction booklet

Support

- Working Video – **Embedded Below**
- Technical Support – WhatsApp@9109087333
- Get Discount Coupon – WhatsApp@9303254433

[Read More](#)

SKU: PH_SPE_67

Price: ~~₹384.00~~ Original price was: ₹384.00. ₹227.00
Current price is: ₹227.00.

Stock: instock

Categories: [Electricity & Magnetism](#), [Physics](#), [Projects](#), [School Project & Experiment](#)

Tags: [class 12th science project and experiment](#), [new science project](#)

Product Description

Download Free Project Synopsis

Disclaimer

This is a handmade complete working Models, Projects & Activity kits supported by rough study material to make a suitable projects report by the student. It is using Cardboard/Wooden base, Paper, Foam based board, stationary items, Electronic-Electrical Components, Mechanical & Scientific goods as per the requirement of a particular model. Colour of product and decoration item may be varying according to availability of material but we make ensure that we will deliver the product with same working, structure and dimensions as describe in product description section.

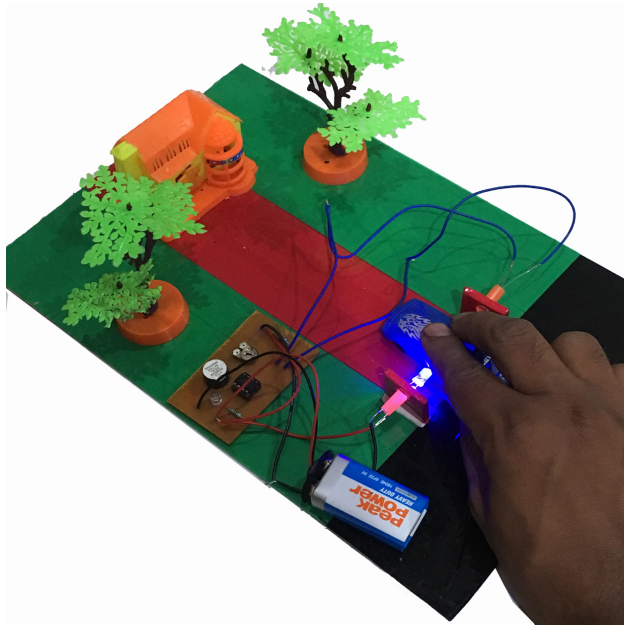

Laser Alarm Security System

Package Includes:

Branding Free Project / Activity kit

- No Brand Name/Logo/Watermark on Components, PCB & Projects
- 100% Working project
- Tested Project & Activity kits

Documentation

- Free Project Synopsis – ***Embedded below***
- Printed instruction booklet

Support

- Working Video – ***Embedded Below***
- Technical Support – WhatsApp@9109087333
- Get Discount Coupon – WhatsApp@9303254433

[Read More](#)

SKU: PH_SEM_03

Price: ₹808.00 Original price was: ₹808.00. ₹477.00
Current price is: ₹477.00.

Stock: instock

Categories: [Exhibition Models & Inspire Award](#),
[Security](#), [Technology & Innovation](#)

Tags: [school science project](#), [science exhibition model](#),
[security system](#)

Product Description

Download Free Project Synopsis

This is a handmade complete working Models, Projects & Activity kits supported by rough study material to make a suitable projects report by the student. It is using Cardboard/Wooden base,

Paper, Foam based board, stationary items, Electronic-Electrical Components, Mechanical & Scientific goods as per the requirement of a particular model. Colour of product and decoration item may be varying according to availability of material but we make ensure that we will deliver the product with same working, structure and dimensions as describe in product description section.

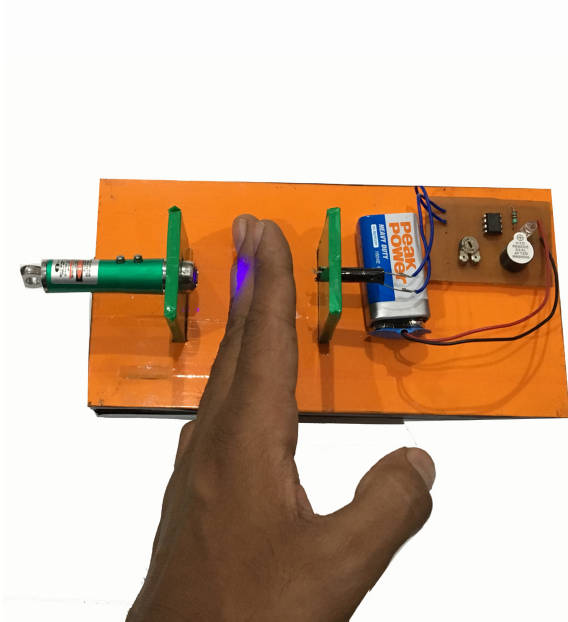

Laser Alarm Security System Working School Science Exhibition Model , DIY Kit

Package Includes:

Branding Free Project / Activity kit

- No Brand Name/Logo/Watermark on Components, PCB & Projects
- 100% Working project
- Tested Project & Activity kits

Documentation

- Free Project Synopsis – ***Embedded below***
- Printed instruction booklet

Support

- Working Video – ***Embedded Below***
- Technical Support – WhatsApp@9109087333
- Get Discount Coupon - WhatsApp@9303254433

[Read More](#)

SKU: PH_SPK_047

Price: ₹480.00 Original price was: ₹480.00. ₹425.00
Current price is: ₹425.00.

Stock: instock

Categories: [Hobby DIY kits](#), [Science Project kit \(SPK\)](#)

Product Description

Download Free Project Synopsis

Working Video

This is a handmade complete working Models, Projects & Activity kits supported by rough study material to make a suitable projects report by the student. It is using Cardboard/Wooden base, Paper, Foam based board, stationary items, Electronic-Electrical Components, Mechanical & Scientific goods as per the requirement of a particular model. Colour of product and decoration item may be varying according to availability of material but we make ensure that we will deliver the product with same working, structure and dimensions as describe in product description section.

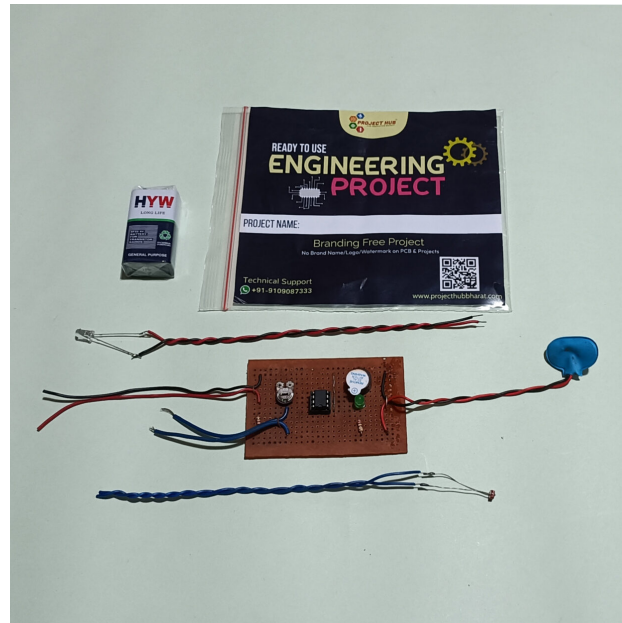

LASER Secu Based Secu Dotted/mult

Package Includ

Branding Free

- No Brand Name
- PCB & Projects
- 100% Working
- Tested Project

Documentation

- Free Project Sy
- Printed instruc
- Printable Soft
- PPT

Support

- Demo Video – **Embedded below**
- Technical Support – WhatsApp@9109087333
- Get Discount Coupon - WhatsApp@9303254433

[Read More](#)

SKU: PH_EP_087

Price: ~~₹392.00~~ Original price was: ₹392.00. ₹231.00
Current price is: ₹231.00.

Stock: instock

Categories: [Engineering project](#), [IC & Transistor](#), [Mini Project](#), [Projects](#)

Product Description

Download Free Project Synopsis

Working Video

This is a handmade complete working Models, Projects & Activity kits supported by rough study material to make a suitable projects report by the student. It is using Cardboard/Wooden base, Paper, Foam based board, stationary items, Electronic-Electrical Components, Mechanical & Scientific goods as per the requirement of a particular model. Colour of product and decoration item may be varying according to availability of material but we make ensure that we will deliver the product with same working, structure and dimensions as describe in product description section.
