



Fire Alarm PCB

Available offer

- **Free Shipping** above Rs999.
- COD available in above 999.
- Pay with UPI QR [Coupons](#)
- **Special Bulk D** Companies and
- Get Special Disc

Highlights

Branding Free Pr

- No Brand Name/ Projects
- 100% Working p
- Tested Project &

Documentation

- Free Project Syn
- Printed Short Re
- Printable Soft co

Support

- Demo Video – **En**
- Technical Suppo
- [Get Discount Co](#)

Click Here to Buy D

[Read More](#)

SKU: PH_EP_022

Price: ~~₹384.00~~ Original price was: ₹384.00. ₹227.00
Current price is: ₹227.00.

Stock: instock

Categories: [Engineering project](#), [IC & Transistor](#), [Mini Project](#), [Projects](#)

Product Description

INTRODUCTION:

The fire alarm project is a safety device designed to detect and alert individuals in the event of a fire outbreak. This project utilizes the IC 555 timer, a widely used integrated circuit, in conjunction with a buzzer, 9V battery, and a 1N4148 Zener diode acting as a heat sensor. The system works by monitoring changes in temperature and triggering an alarm when the temperature exceeds a predefined threshold, indicating the presence of fire or excessive heat.

ADVANTAGES:

- Cost-effective solution for fire detection.
- Simple circuit design using easily available components.
- Portable and battery-powered, allowing it to be used in various settings.
- Provides an immediate audible alert to warn occupants of potential danger.
- Can be integrated into larger fire safety systems.

APPLICATIONS:

- Residential buildings: Houses, apartments, and dormitories.
- Offices and commercial spaces.
- Industrial facilities and warehouses.
- Educational institutions: Schools, colleges, and universities.
- Public places: Theatre's, shopping malls, and airports.
- Any location where early fire detection is crucial for safety.

[Download Free Project Synopsis](#)

[Working Video](#)

Disclaimer:

This is a handmade complete working Models, Projects & Activity kits supported by rough study material to make a suitable projects report by the student. It is using Cardboard/Wooden base, Paper, Foam based board, stationary items, Electronic-Electrical Components, Mechanical & Scientific goods as per the requirement of a particular model. Colour of product and decoration item may be varying according to availability of material but we make ensure that we will deliver the product with same working, structure and dimensions as describe in product description section.

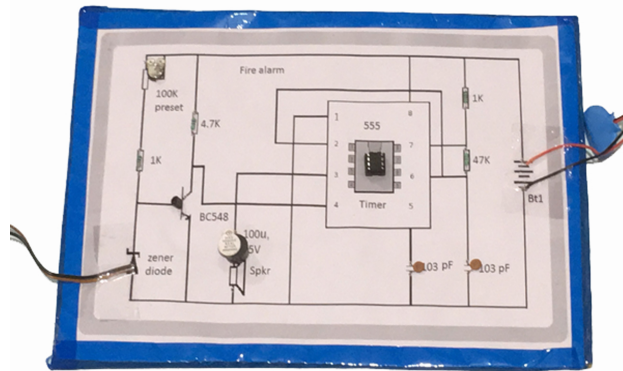

Fire Alarm

Package Includes

Branding Free

- No Brand Name
- PCB & Projects
- Tested Activity

Documentation

- Free Project Sy
- Printed instruc

Support

- Working Video
- Technical Supp
- Get Discount C

[Read More](#)

SKU: PH_SPE_54

Price: ₹320.00 Orig
Current price is: ₹2

Stock: instock

Categories: [Electronics](#), [Projects](#), [School Project & Experiment](#)

Tags: [class 12th science project and experiment](#), [new science project](#)

Product Description

Download Free Project Synopsis

Disclaimer

This is a handmade complete working Models, Projects & Activity kits supported by rough study material to make a suitable projects report by the student. It is using Cardboard/Wooden base, Paper, Foam based board, stationary items, Electronic-Electrical Components, Mechanical & Scientific goods as per the requirement of a particular model. Colour of product and decoration item may be varying according to availability of material but we make ensure that we will deliver the product with same working, structure and dimensions as describe in product description section.

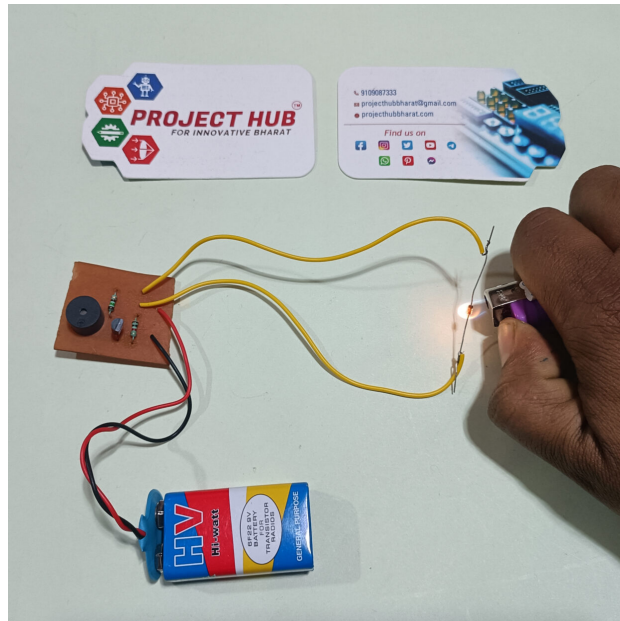

Fire Alarm u Diode

Available offer

- **Free Shipping** above Rs999.
- Pay with UPI QR [Coupons](#)
- **Special Bulk D** Companies and
- Get Special Dis 9109087333.

Highlights

Branding Free Pr

- No Brand Name/Logo/Watermark on Components, PCB & Projects
- 100% Working project
- Tested Project & Activity kits

Documentation

- Free Project Synopsis - **Embedded below**
- Printed Short Report
- Printable Soft copy of Project Report

Support

- Demo Video - **Embedded below**
- Technical Support - WhatsApp@9109087333
- [Get Discount Coupon](#)

Delivery Time

- **Handling Period** : 1-2 Days
- **Transit Time** :3-5 Days (Approx.)
- **Delivery Time** : Handling Period + Transit Time (4-7 Days Approx.)

[Read More](#)

SKU: PH_EP_134

Price:

Stock: instock

Categories: [Engineering project](#), [IC & Transistor](#), [Mini Project](#), [Projects](#)

Product Description

Download Free Project Synopsis

Working Video:

Disclaimer:

This is a handmade complete working Models, Projects & Activity kits supported by rough study material to make a suitable projects report by the student. It is using Cardboard/Wooden base, Paper, Foam based board, stationary items, Electronic-Electrical Components, Mechanical & Scientific goods as per the requirement of a particular model. Colour of product and decoration item may be varying according to availability of material but we make ensure that we will deliver the product with same working, structure and dimensions as describe in product description section.

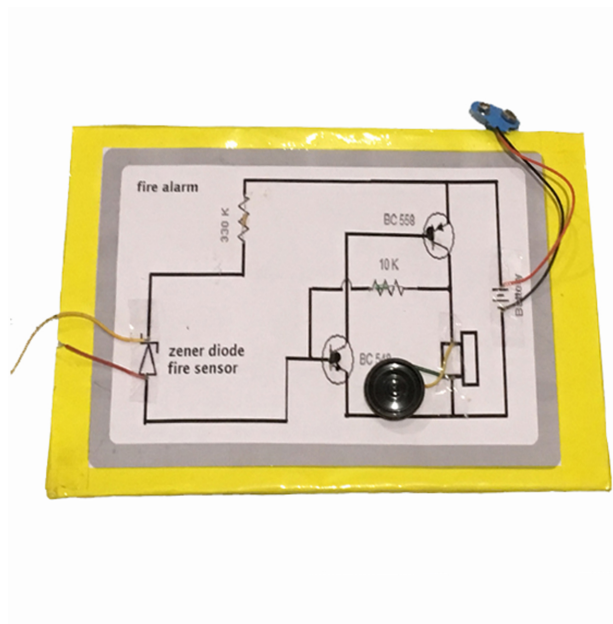

Fire Alarm U

Package Includ

Branding Free

- No Brand Name
- PCB & Projects
- Tested Activity

Documentation

- Free Project Sy
- Printed instruc

Support

- Working Video
- Technical Supp
- Get Discount C

[Read More](#)

SKU: PH_SPE_55

Price: ₹220.00 Orig
Current price is: ₹1

Stock: instock

Categories: [Electr](#)
[Experiment](#)

Tags: [class 12th science project and experiment](#), [new science project](#)

Product Description

Download Free Project Synopsis

Disclaimer

This is a handmade complete working Models, Projects & Activity kits supported by rough study material to make a suitable projects report by the student. It is using Cardboard/Wooden base, Paper, Foam based board, stationary items, Electronic-Electrical Components, Mechanical & Scientific goods as per the requirement of a particular model. Colour of product and decoration item may be varying according to availability of material but we make ensure that we will deliver the product with same working, structure and dimensions as describe in product description section.

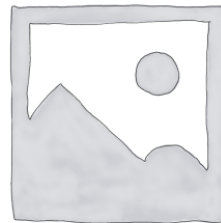

Fire Fighting Module

Available offer

- **Free Shipping** orders above ₹
- Pay with UPI Q Discount./ [Cou](#)
- **Special Bulk** Companies an
- Get Special Dis WhatsApp@91

Highlights

Branding Free Pr

- No Brand Name/Logo/Watermark on Components, PCB & Projects
- 100% Working project
- Tested Project & Activity kits

Documentation

- Free Project Synopsis – **Embedded below**
- Printed Short Report
- Printable Soft copy of Project Report

Support

- Demo Video – **Embedded below**
- Technical Support – WhatsApp@9109087333
- [Get Discount Coupon](#)

Delivery Time

- **Handling Period** : 1-2 Days
- **Transit Time** :3-5 Days (Approx.)
- **Delivery Time** : Handling Period + Transit Time (4-7 Days Approx.)

Click Here to Buy Do It Yourself Kit

[Read More](#)

SKU: PH_EP_107

Price:

Stock: instock

Categories: [Arduino](#), [Engineering project](#), [Mechanical Projects](#), [Robotics](#)

Product Description

Download Free Project Synopsis

Working Video

Disclaimer:

This is a handmade complete working Models, Projects & Activity kits supported by rough study material to make a suitable projects report by the student. It is using Cardboard/Wooden base, Paper, Foam based board, stationary items, Electronic-Electrical Components, Mechanical & Scientific goods as per the requirement of a particular model. Colour of product and decoration item may be varying according to availability of material but we make ensure that we will deliver the product with same working, structure and dimensions as describe in product description section.

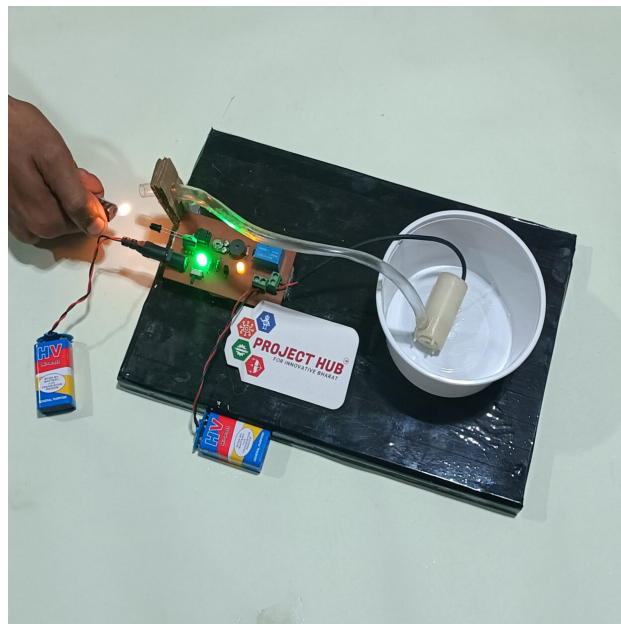

Flame Dete Water Sprin

Available offer

- **Free Shipping** above Rs999.
- Pay with UPI QR [Coupons](#)
- **Special Bulk D** Companies and
- Get Special Disc

Highlights

Branding Free Pr

- No Brand Name/ Projects
- 100% Working p
- Tested Project &

Documentation

- Free Project Synopsis – **Embedded below**
- Printed Short Report
- Printable Soft copy of Project Report (10-15 Page)

Support

- Demo Video – **Embedded below**
- Technical Support – WhatsApp@9109087333
- [Get Discount Coupon](#)

Click Here to Buy Do It Yourself Kit Click Here to Buy Digital Bundle Click Here to Buy Full Project Report

- Printable Soft copy of Project Report (30 -35 Pages)
- Printable Soft copy of Project Report (60 -70 Pages)

[Read More](#)

SKU: PH_EP_040

Price: ₹1,396.00 Original price was: ₹1,396.00. ₹824.00 Current price is: ₹824.00.

Stock: instock

Categories: [Engineering project](#), [IC & Transistor](#), [Projects](#)

Product Description

Disclaimer:

This is a handmade complete working Models, Projects & Activity kits supported by rough study material to make a suitable projects report by the student. It is using Cardboard/Wooden base, Paper, Foam based board, stationary items, Electronic-Electrical Components, Mechanical & Scientific goods as per the requirement of a particular model. Colour of product and decoration item may be varying according to availability of material but we make ensure that we will deliver the product with same working, structure and dimensions as describe in product description section.

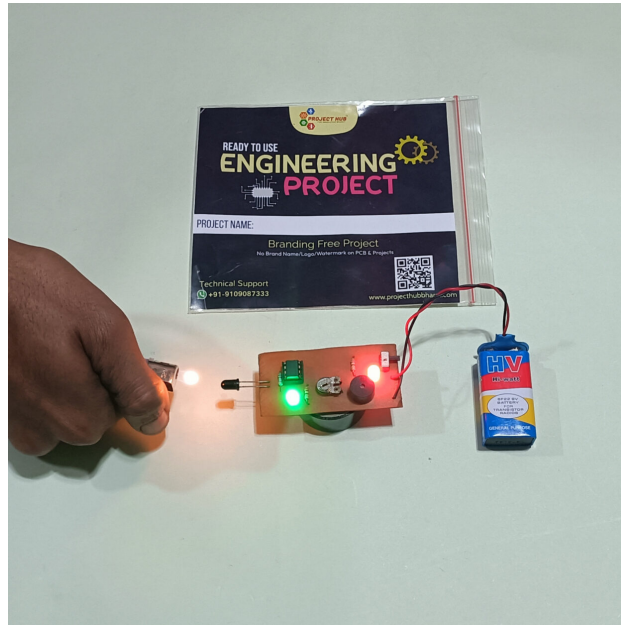

Flame detector

Available offer

- **Free Shipping** above Rs999.
- Pay with UPI QR [Coupons](#)
- **Special Bulk D** Companies and
- Get Special Disc

Highlights

Branding Free Pr

- No Brand Name/ Projects
- 100% Working p
- Tested Project &

Documentation

- Free Project Syn
- Printed Short Re
- Printable Soft co

Support

- Demo Video – **En**
- Technical Suppo
- [Get Discount Co](#)

[Read More](#)

SKU: PH_EP_045

Price: ₹400.00 Orig
Current price is: ₹2

Stock: instock

Categories: [Engineering project](#), [IC & Transistor](#), [Mini Project](#), [Projects](#)

Product Description

Download Free Project Synopsis

Working Video

Disclaimer:

This is a handmade complete working Models, Projects & Activity kits supported by rough study material to make a suitable projects report by the student. It is using Cardboard/Wooden base, Paper, Foam based board, stationary items, Electronic-Electrical Components, Mechanical & Scientific goods as per the requirement of a particular model. Colour of product and decoration item may be varying according to availability of material but we make ensure that we will deliver the product with same working, structure and dimensions as describe in product description section.

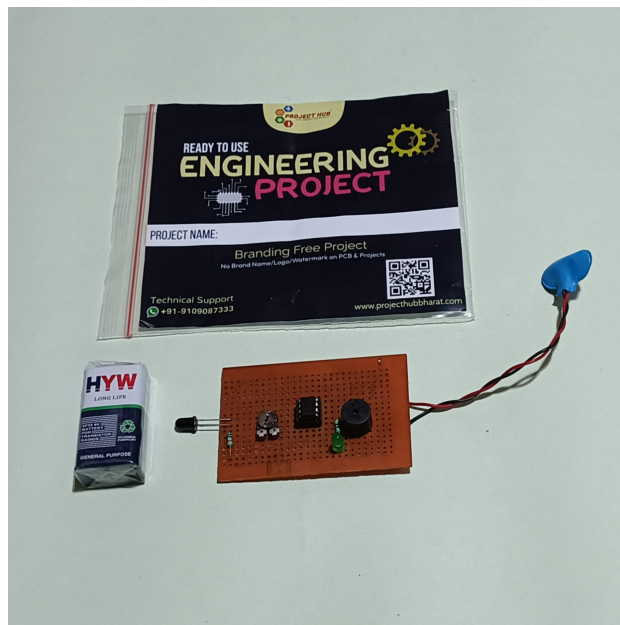

Flame detect

Package Includ

Branding Free

- No Brand Name
- PCB & Projects
- 100% Working
- Tested Project

Documentation

- Free Project Sy

- Printed instruction booklet
- Printable Soft copy of Project Report
- PPT

Support

- Demo Video – **Embedded below**
- Technical Support – WhatsApp@9109087333
- Get Discount Coupon – WhatsApp@9303254433

[Read More](#)

SKU: PH_EP_092

Price: ~~₹384.00~~ Original price was: ₹384.00. ₹227.00
Current price is: ₹227.00.

Stock: instock

Categories: [Engineering project](#), [IC & Transistor](#), [Mini Project](#), [Projects](#), [Security](#)

Product Description

Download Free Project Synopsis

Working Video

This is a handmade complete working Models, Projects & Activity kits supported by rough study material to make a suitable projects report by the student. It is using Cardboard/Wooden base, Paper, Foam based board, stationary items, Electronic-Electrical Components, Mechanical & Scientific goods as per the requirement of a particular model. Colour of product and decoration item may be varying according to availability of material but we make ensure that we will deliver the product with same working, structure and dimensions as describe in product description section.

Food Chain

Kit Includes:

- **Project Kit**
- **9V Battery**
- **Print Short R**

Available offers:

- **Free Shipping**
orders above ₹
- **Pay with UPI**
Discount./[Coupo](#)
- **Special Bulk**
Companies an
- **Get Special D**
WhatsApp@91

Highlights Brand

- No Brand Nam
- PCB & Projects
- 100% Working
- Tested Project

Documentation

- Printed Short F
- Printable Soft

Support

- Demo Video –
- Technical Supp
- [Get Discount C](#)

[Read More](#)

SKU: PH_SPE_34

Price:

Stock: instock



Categories: [Biology](#), [Projects](#), [School Project & Experiment](#)

Product Description



Full Wave B

Available offer

- **Free Shipping** above Rs999.
- Pay with UPI QR [Coupons](#)
- **Special Bulk D** Companies and r
- Get Special Disc

Highlights

Branding Free Pr

- No Brand Name/ Projects
- 100% Working p
- Tested Project &

Documentation

- Free Project Syn
- Printed Short Re
- Printable Soft co

Support

- Demo Video – **Er**
- Technical Suppo
- [Get Discount Co](#)

[Read More](#)

SKU: PH_EP_080

Price: ~~₹660.00~~ Original price was: ₹660.00. ₹389.00
Current price is: ₹389.00.

Stock: instock

Categories: [Engineering project](#), [IC & Transistor](#),
[Projects](#)

Product Description

Download Free Project Synopsis

Working Video

Disclaimer:

This is a handmade complete working Models, Projects & Activity kits supported by rough study material to make a suitable projects report by the student. It is using Cardboard/Wooden base, Paper, Foam based board, stationary items, Electronic-Electrical Components, Mechanical & Scientific goods as per the requirement of a particular model. Colour of product and decoration item may be varying according to availability of material but we make ensure that we will deliver the product with same working, structure and dimensions as describe in product description section.



Full Wave R

Available offer

- **Free Shipping** above Rs999.
- Pay with UPI QR [Coupons](#)
- **Special Bulk D** Companies and
- Get Special Disc

Highlights

Branding Free Pr

- No Brand Name/ Projects
- 100% Working p
- Tested Project &

Documentation

- Free Project Syn
- Printed Short Re
- Printable Soft co

Support

- Demo Video – **En**
- Technical Suppo
- [Get Discount Co](#)

[Read More](#)

SKU: PH_EP_079

Price: ₹628.00 Orig
Current price is: ₹3

Stock: instock

Categories: [Engineering project](#), [IC & Transistor, Projects](#)

Product Description

[Download Free Project Synopsis](#)

[Working Video](#)

Disclaimer:

This is a handmade complete working Models, Projects & Activity kits supported by rough study material to make a suitable projects report by the student. It is using Cardboard/Wooden base, Paper, Foam based board, stationary items, Electronic-Electrical Components, Mechanical & Scientific goods as per the requirement of a particular model. Colour of product and decoration item may be varying according to availability of material but we make ensure that we will deliver the product with same working, structure and dimensions as describe in product description section.

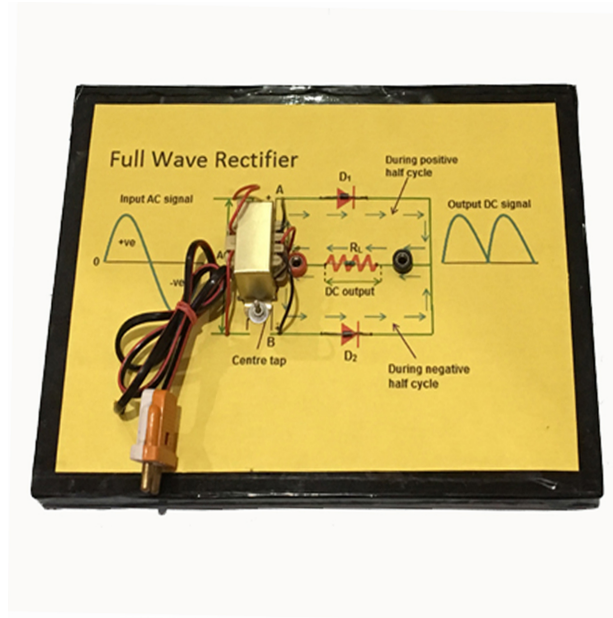

Full wave re

Package Includ

Branding Free

- No Brand Name
- PCB & Projects
- Tested Activity

Documentation

- Free Project Sy
- Printed instruc

Support

- Working Video – **Embedded Below**
- Technical Support – WhatsApp@9109087333
- Get Discount Coupon - WhatsApp@9303254433

[Read More](#)

SKU: PH_SPE_56

Price: ~~₹500.00~~ Original price was: ₹500.00. ₹480.00
Current price is: ₹480.00.

Stock: instock

Categories: [Electricity & Magnetism](#), [Electronics](#),
[Physics](#), [Projects](#), [School Project & Experiment](#)

Tags: [class 12th science project and experiment](#), [new science project](#)

Product Description

Download Free Project Synopsis

Disclaimer

This is a handmade complete working Models, Projects & Activity kits supported by rough study material to make a suitable projects report by the student. It is using Cardboard/Wooden base, Paper, Foam based board, stationary items, Electronic-Electrical Components, Mechanical & Scientific goods as per the requirement of a particular model. Colour of product and decoration item may be varying according to availability of material but we make ensure that we will deliver the product with same working, structure and dimensions as describe in product description section.



Gas Leakage System Using LCD 16X2

Available offer

- **Free Shipping** on orders above ₹1000
- Pay with UPI QR Code, Bank Discount./ [Coupons](#)
- **Special Bulk** prices for Companies and Institutions
- Get Special Discount on [WhatsApp@919999999999](#)

Highlights

Branding Free Project

- No Brand Name on PCB & Projects
- 100% Working Project
- Tested Project

Documentation

- Free Project System
- Printed Short Form
- Printable Software

Support

- Demo Video – [Watch](#)
- Technical Support – [Contact](#)
- [Get Discount Coupon](#)

[Read More](#)

SKU: PH_EP_053

Price:

Stock: instock

Categories: [Arduino](#), [Engineering project](#), [Projects](#)

Product Description

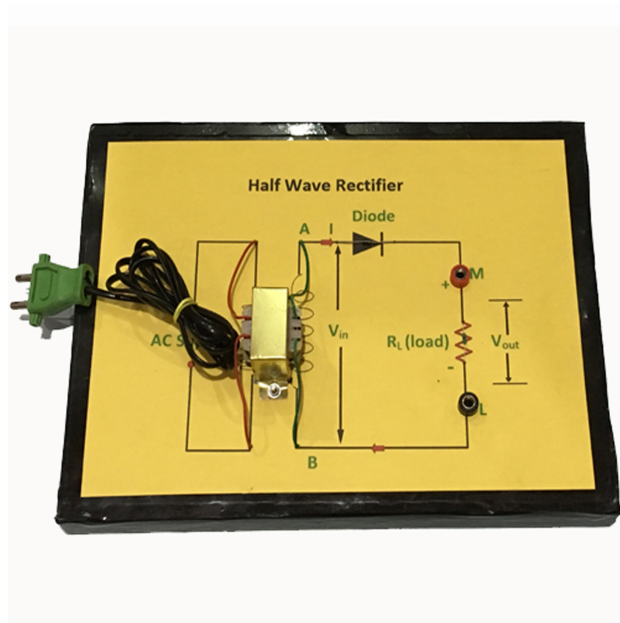

Half wave r

Package Includ

Branding Free

- No Brand Name
- PCB & Projects
- Tested Activity

Documentation

- Free Project Sy
- Printed instruc

Support

- Working Video
- Technical Supp
- Get Discount C

[Read More](#)

SKU: PH_SPE_59

Price: ₹500.00 Orig
Current price is: ₹4

Stock: instock

Categories: [Electr](#)
[Physics](#), [Projects](#), [S](#)

Tags: [class 12th science project and experiment](#), [new science project](#)

Product Description

Download Free Project Synopsis

Disclaimer

This is a handmade complete working Models, Projects & Activity kits supported by rough study material to make a suitable projects report by the student. It is using Cardboard/Wooden base, Paper, Foam based board, stationary items, Electronic-Electrical Components, Mechanical & Scientific goods as per the requirement of a particular model. Colour of product and decoration item may be varying according to availability of material but we make ensure that we will deliver the product with same working, structure and dimensions as describe in product description section.

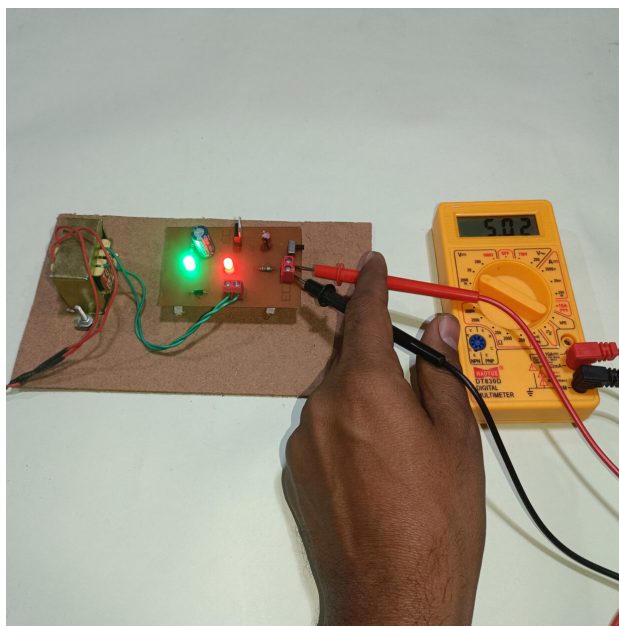

Halfwave R

Available offer

- **Free Shipping** above Rs999.
- Pay with UPI QR [Coupons](#)
- **Special Bulk D** Companies and
- Get Special Disc

Highlights

Branding Free Pr

- No Brand Name/ Projects
- 100% Working p

- Tested Project & Activity kits

Documentation

- Free Project Synopsis – **Embedded below**
- Printed Short Report
- Printable Soft copy of Project Report (10-15 Page)

Support

- Demo Video – **Embedded below**
- Technical Support – WhatsApp@9109087333
- [Get Discount Coupon](#)

[Read More](#)

SKU: PH_EP_078

Price: ~~₹624.00~~ Original price was: ₹624.00. ₹368.00
Current price is: ₹368.00.

Stock: instock

Categories: [Engineering project](#), [IC & Transistor](#), [Projects](#)

Product Description

Download Free Project Synopsis

Working Video

Disclaimer:

This is a handmade complete working Models, Projects & Activity kits supported by rough study material to make a suitable projects report by the student. It is using Cardboard/Wooden base, Paper, Foam based board, stationary items, Electronic-Electrical Components, Mechanical & Scientific goods as per the requirement of a particular model. Colour of product and decoration item may be varying according to availability of material but we make ensure that we will deliver the product with same working, structure and dimensions as describe in product

description section.

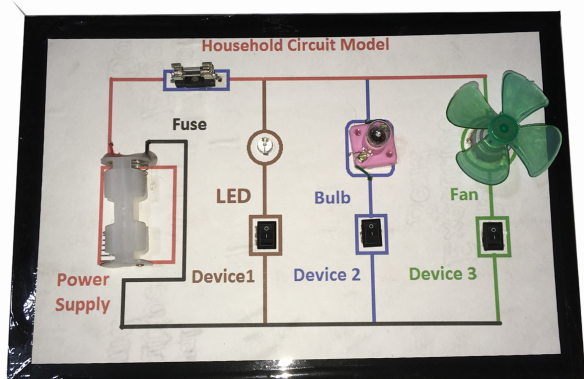

Household Circuit Model

Package Includes:

Branding Free Activity kit

- No Brand Name/Logo/Watermark on Components, PCB & Projects
- Tested Activity kits

Documentation

- Free Project Synopsis – **Embedded below**
- Printed instruction booklet

Support

- Working Video – **Embedded Below**
- Technical Support – WhatsApp@9109087333
- Get Discount Coupon – WhatsApp@9303254433

[Read More](#)

SKU: PH_SPE_61

Price: ~~₹480.00~~ Original price was: ₹480.00. ₹440.00
Current price is: ₹440.00.

Stock: instock

Categories: [Electricity & Magnetism](#), [Physics](#), [Projects](#), [School Project & Experiment](#)

Tags: [class 12th science project and experiment](#), [new science project](#)

Product Description

Download Free Project Synopsis

Disclaimer

This is a handmade complete working Models, Projects & Activity kits supported by rough study material to make a suitable projects report by the student. It is using Cardboard/Wooden base, Paper, Foam based board, stationary items, Electronic-Electrical Components, Mechanical & Scientific goods as per the requirement of a particular model. Colour of product and decoration item may be varying according to availability of material but we make ensure that we will deliver the product with same working, structure and dimensions as describe in product description section.



Intelligent C Detector cu regulator of & LCD

Available offer

- **Free Shipping**
orders above ₹
- Pay with UPI Q
Discount./ [Cou](#)
- **Special Bulk**
Companies an
- Get Special Dis
WhatsApp@91

Highlights

Branding Free Pr

- No Brand Nam
PCB & Projects
- 100% Working
- Tested Project

Documentation

- Free Project Synopsis – **Embedded below**
- Printed Short Report
- Printable Soft copy of Project Report

Support

- Demo Video – **Embedded below**
- Technical Support – WhatsApp@9109087333
- [Get Discount Coupon](#)

[Read More](#)

SKU: PH_EP_054

Price:

Stock: instock

Categories: [Arduino](#), [Engineering project](#), [Projects](#)

Product Description

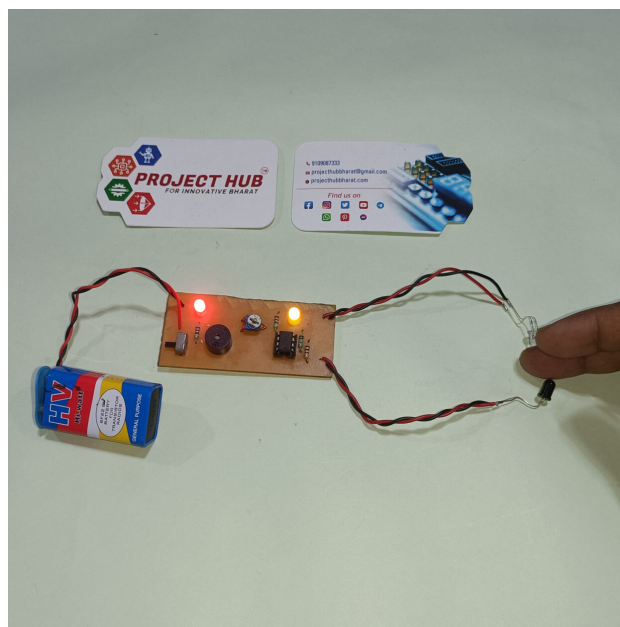

Invisible Bu

Available offer

- **Free Shipping** above Rs999.
- Pay with UPI QR [Coupons](#)
- **Special Bulk D** Companies and I
- Get Special Disc

Highlights

Branding Free Pr

- No Brand Name/Logo/Watermark on Components, PCB & Projects
- 100% Working project
- Tested Project & Activity kits

Documentation

- Free Project Synopsis – **Embedded below**
- Printed Short Report
- Printable Soft copy of Project Report (10-15 Page)

Support

- Demo Video – **Embedded below**
- Technical Support – WhatsApp@9109087333
- [Get Discount Coupon](#)

[Read More](#)

SKU: PH_EP_085

Price: ₹436.00 Original price was: ₹436.00. ₹257.00
Current price is: ₹257.00.

Stock: instock

Categories: [Engineering project](#), [IC & Transistor](#), [Mini Project](#), [Projects](#)

Product Description

Download Free Project Synopsis

Working Video

Disclaimer:

This is a handmade complete working Models, Projects & Activity kits supported by rough study material to make a suitable projects report by the student. It is using Cardboard/Wooden base, Paper, Foam based board, stationary items, Electronic-Electrical Components, Mechanical &

Scientific goods as per the requirement of a particular model. Colour of product and decoration item may be varying according to availability of material but we make ensure that we will deliver the product with same working, structure and dimensions as describe in product description section.



Ionic bond i

Kit Includes:

- **Project Kit**
- **9V Battery**
- **Print Short R**

Available offers:

- **Free Shipping**
orders above ₹
- **Pay with UPI**
Discount./[Cou](#)
- **Special Bulk**
Companies an
- **Get Special D**
WhatsApp@91

Highlights Brand

- No Brand Nam
PCB & Projects
- 100% Working
- Tested Project

Documentation

- Printed Short F
- Printable Soft

Support

- Demo Video –
- Technical Supp

- [Get Discount Coupon](#)

[Read More](#)

SKU: PH_SPE_28

Price:

Stock: instock

Categories: [Chemistry](#), [Projects](#), [School Project & Experiment](#)

Product Description



IOT based F Alert System

Available offer

- **Free Shipping**
orders above ₹
- Pay with UPI Q
Discount./ [Cou](#)
- **Special Bulk**
Companies an
- Get Special Dis
WhatsApp@91

Highlights

Branding Free Pr

- No Brand Nam
PCB & Projects
- 100% Working
- Tested Project

Documentation

- Free Project Synopsis – **Embedded below**
- Printed Short Report
- Printable Soft copy of Project Report

Support

- Demo Video – **Embedded below**
- Technical Support – WhatsApp@9109087333
- [Get Discount Coupon](#)

[Read More](#)

SKU: PH_EP_075

Price:

Stock: instock

Categories: [Engineering project](#), [IOT](#), [Projects](#)

Product Description



IOT based f using Node

Available offer

- **Free Shipping**
orders above ₹
- Pay with UPI Q
Discount./ [Cou](#)
- **Special Bulk**
Companies an
- Get Special Dis
WhatsApp@91

Highlights

Branding Free Project / Activity kit

- No Brand Name/Logo/Watermark on Components, PCB & Projects
- 100% Working project
- Tested Project & Activity kits

Documentation

- Free Project Synopsis – **Embedded below**
- Printed Short Report
- Printable Soft copy of Project Report

Support

- Demo Video – **Embedded below**
- Technical Support – WhatsApp@9109087333
- [Get Discount Coupon](#)

Delivery Time

- **Handling Period** : 1-2 Days
- **Transit Time** :3-5 Days (Approx.)
- **Delivery Time** : Handling Period + Transit Time (4-7 Days Approx.)

Click Here to Buy Do It Yourself Kit

[Read More](#)

SKU: PH_EP_111

Price:

Stock: instock

Categories: [Engineering project](#), [Mechanical](#), [Projects](#), [Robotics](#)

Product Description

Download Free Project Synopsis

Working Video

Disclaimer:

This is a handmade complete working Models, Projects & Activity kits supported by rough study material to make a suitable projects report by the student. It is using Cardboard/Wooden base, Paper, Foam based board, stationary items, Electronic-Electrical Components, Mechanical & Scientific goods as per the requirement of a particular model. Colour of product and decoration item may be varying according to availability of material but we make ensure that we will deliver the product with same working, structure and dimensions as describe in product description section.



IOT based S system usin DHT11 Sens

Available offer

- **Free Shipping**
orders above ₹
- Pay with UPI Q
Discount./ [Cou](#)
- **Special Bulk**
Companies an
- Get Special Dis
WhatsApp@91

Highlights

Branding Free Pr

- No Brand Nam
PCB & Projects
- 100% Working

- Tested Project & Activity kits

Documentation

- Free Project Synopsis – **Embedded below**
- Printed Short Report
- Printable Soft copy of Project Report

Support

- Demo Video – **Embedded below**
- Technical Support – WhatsApp@9109087333
- [Get Discount Coupon](#)

[Read More](#)

SKU: PH_EP_074

Price:

Stock: instock

Categories: [Engineering project](#), [IOT](#), [Projects](#)

Product Description

IOT based V

Available offer

- **Free Shipping**
orders above ₹
- Pay with UPI Q
Discount./ [Cou](#)
- **Special Bulk**
Companies an
- Get Special Dis
WhatsApp@91



Highlights

Branding Free Project / Activity kit

- No Brand Name/Logo/Watermark on Components, PCB & Projects
- 100% Working project
- Tested Project & Activity kits

Documentation

- Free Project Synopsis – **Embedded below**
- Printed Short Report
- Printable Soft copy of Project Report

Support

- Demo Video – **Embedded below**
- Technical Support – WhatsApp@9109087333
- [Get Discount Coupon](#)

Delivery Time

- **Handling Period** : 1-2 Days
- **Transit Time** :3-5 Days (Approx.)
- **Delivery Time** : Handling Period + Transit Time (4-7 Days Approx.)

Click Here to Buy Do It Yourself Kit

[Read More](#)

SKU: PH_EP_110

Price:

Stock: instock

Categories: [Engineering project](#), [Mechanical](#), [Projects](#), [Robotics](#)

Product Description

Download Free Project Synopsis

Working Video

Disclaimer:

This is a handmade complete working Models, Projects & Activity kits supported by rough study material to make a suitable projects report by the student. It is using Cardboard/Wooden base, Paper, Foam based board, stationary items, Electronic-Electrical Components, Mechanical & Scientific goods as per the requirement of a particular model. Colour of product and decoration item may be varying according to availability of material but we make ensure that we will deliver the product with same working, structure and dimensions as describe in product description section.

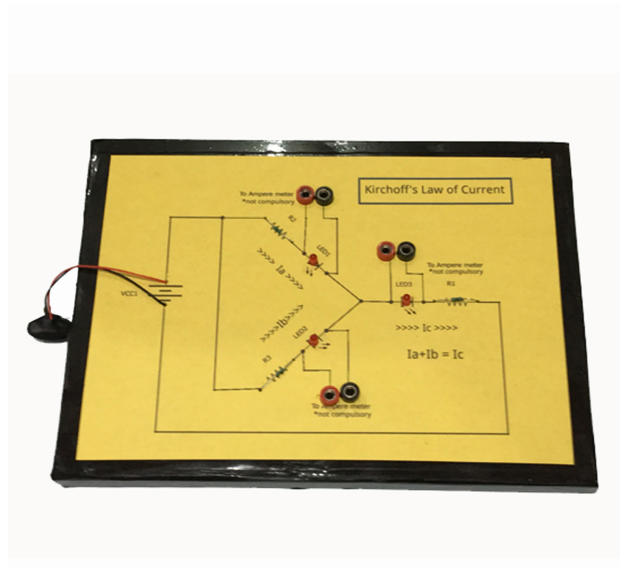

Kirchoff's Law

Package Includes

Branding Free

- No Brand Name
- PCB & Projects
- Tested Activity

Documentation

- Free Project Syn
- Printed instruc

Support

- Working Video
- Technical Supp
- Get Discount C

[Read More](#)

SKU: PH_SPE_64

Price: ~~₹400.00~~ Original price was: ₹400.00. ₹340.00
Current price is: ₹340.00.

Stock: instock

Categories: [Electricity & Magnetism](#), [Physics](#), [Projects](#), [School Project & Experiment](#)

Tags: [class 12th science project and experiment](#), [new science project](#)

Product Description

Download Free Project Synopsis

Disclaimer

This is a handmade complete working Models, Projects & Activity kits supported by rough study material to make a suitable projects report by the student. It is using Cardboard/Wooden base, Paper, Foam based board, stationary items, Electronic-Electrical Components, Mechanical & Scientific goods as per the requirement of a particular model. Colour of product and decoration item may be varying according to availability of material but we make ensure that we will deliver the product with same working, structure and dimensions as describe in product description section.
