

## Diode Action or Switching

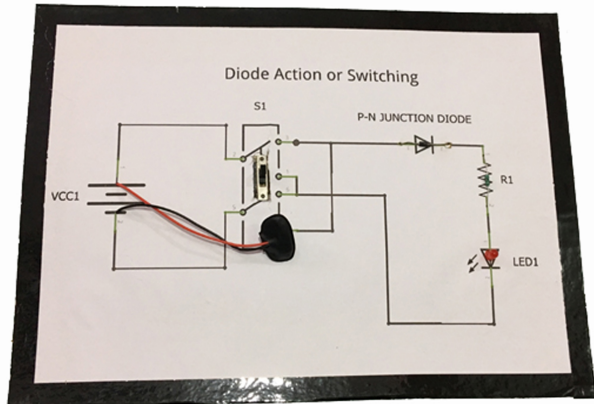

### Package Includes:

### Branding Free Activity kit

- No Brand Name/Logo/Watermark on Components, PCB & Projects
- Tested Activity kits

### Documentation

- Free Project Synopsis – **Embedded below**
- Printed instruction booklet

### Support

- Working Video – **Embedded Below**
- Technical Support – WhatsApp@9109087333
- Get Discount Coupon – WhatsApp@9303254433

[Read More](#)

**SKU:** PH\_SPE\_39

**Price:** ~~₹524.00~~ Original price was: ₹524.00. ₹309.00

Current price is: ₹309.00.

**Stock:** instock

**Categories:** [Electronics](#), [Physics](#), [Projects](#), [School Project & Experiment](#)

**Tags:** [class 12th science project and experiment](#), [new science project](#)

### Product Description

## Download Free Project Synopsis

## Disclaimer

This is a handmade complete working Models, Projects & Activity kits supported by rough study material to make a suitable projects report by the student. It is using Cardboard/Wooden base, Paper, Foam based board, stationary items, Electronic-Electrical Components, Mechanical & Scientific goods as per the requirement of a particular model. Colour of product and decoration item may be varying according to availability of material but we make ensure that we will deliver the product with same working, structure and dimensions as describe in product description section.

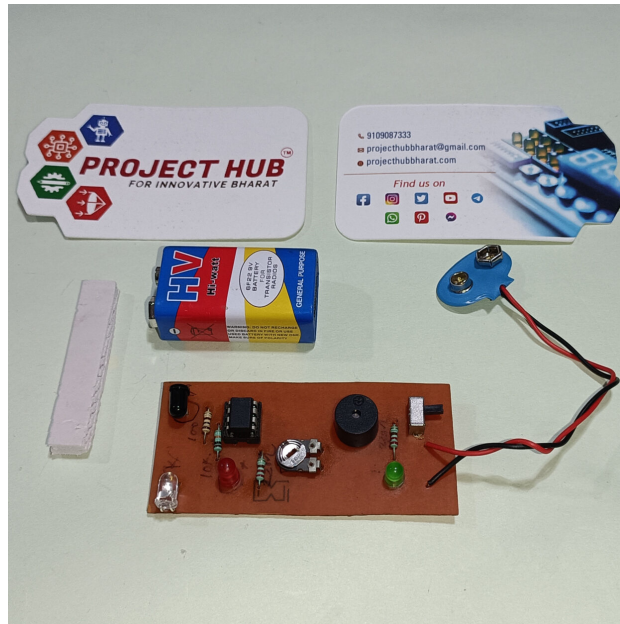

## Door Opening Sensor

### Available offer

- **Free Shipping** above Rs999.
- Pay with UPI QR [Coupons](#)
- **Special Bulk D** Companies and
- Get Special Dis 9109087333.

### Highlights

#### Branding Free Pr

- No Brand Name/ Projects
- 100% Working p
- Tested Project &

#### Documentation

- Free Project Syn

- Printed Short Report
- Printable Soft copy of Project Report

### Support

- Demo Video – **Embedded below**
- Technical Support – WhatsApp@9109087333
- [Get Discount Coupon](#)

### Delivery Time

- **Handling Period** : 1-2 Days
- **Transit Time** :3-5 Days (Approx.)
- **Delivery Time** : Handling Period + Transit Time (4-7 Days Approx.)

[Read More](#)

**SKU:** PH\_EP\_007

**Price:** ~~₹420.00~~ Original price was: ₹420.00. ₹248.00  
Current price is: ₹248.00.

**Stock:** instock

**Categories:** [Engineering project](#), [IC & Transistor](#), [Mini Project](#), [Projects](#)

## Product Description

## Download Free Project Synopsis

## Working Video

This is a handmade complete working Models, Projects & Activity kits supported by rough study material to make a suitable projects report by the student. It is using Cardboard/Wooden base, Paper, Foam based board, stationary items, Electronic-Electrical Components, Mechanical & Scientific goods as per the requirement of a particular model. Colour of product and decoration item may be varying according to availability of material but we make ensure that we will deliver the product with same working, structure and dimensions as describe in product description section.

---



## Door Opening Transistor &

### Available offer

- **Free Shipping** above Rs999.
- Pay with UPI QR [Coupons](#)
- **Special Bulk D** Companies and
- Get Special Dis 9109087333.

### Highlights

#### Branding Free Pr

- No Brand Name/ Projects
- 100% Working p
- Tested Project &

#### Documentation

- Free Project Syn
- Printed Short Re
- Printable Soft co

#### Support

- Demo Video – **En**
- Technical Suppo
- [Get Discount Co](#)

#### Delivery Time

- **Handling Perio**

- **Transit Time** :3-5 Days (Approx.)
- **Delivery Time** : Handling Period + Transit Time (4-7 Days Approx.)

[Read More](#)

**SKU:** PH\_EP\_125

**Price:** ~~₹332.00~~ Original price was: ₹332.00. ₹196.00  
Current price is: ₹196.00.

**Stock:** instock

**Categories:** [Engineering project](#), [IC & Transistor](#), [Mini Project](#), [Projects](#)

## Product Description

---

[Download Free Project Synopsis](#)

---

[Working Video:](#)

---

### Disclaimer:

This is a handmade complete working Models, Projects & Activity kits supported by rough study material to make a suitable projects report by the student. It is using Cardboard/Wooden base, Paper, Foam based board, stationary items, Electronic-Electrical Components, Mechanical & Scientific goods as per the requirement of a particular model. Colour of product and decoration item may be varying according to availability of material but we make ensure that we will deliver the product with same working, structure and dimensions as describe in product description section.

---



## Edge Avoidance Arduino & I

### Available offer

- **Free Shipping**  
orders above ₹
- Pay with UPI QR  
Discount./ [Cou](#)
- **Special Bulk**  
Companies and
- Get Special Dis  
WhatsApp@91

### Highlights

#### Branding Free Pr

- No Brand Name  
PCB & Projects
- 100% Working
- Tested Project

#### Documentation

- Free Project Sy
- Printed Short P
- Printable Soft

#### Support

- Demo Video –
- Technical Supp
- [Get Discount C](#)

#### Delivery Time

- **Handling Period** : 1-2 Days
- **Transit Time** :3-5 Days (Approx.)
- **Delivery Time** : Handling Period + Transit Time (4-7 Days Approx.)

Click Here to Buy Do It Yourself Kit

[Read More](#)

**SKU:** PH\_EP\_106

**Price:**

**Stock:** instock

**Categories:** [Arduino](#), [Engineering project](#), [Mechanical Projects](#), [Robotics](#)

## Product Description

## Download Free Project Synopsis

---

## Working Video

---

### **Disclaimer:**

This is a handmade complete working Models, Projects & Activity kits supported by rough study material to make a suitable projects report by the student. It is using Cardboard/Wooden base, Paper, Foam based board, stationary items, Electronic-Electrical Components, Mechanical & Scientific goods as per the requirement of a particular model. Colour of product and decoration item may be varying according to availability of material but we make ensure that we will deliver the product with same working, structure and dimensions as describe in product description section.

---



## Electric Fuse

### Kit Includes:

- **Project Kit**
- **9V Battery**
- **Print Short R**

### Available offers:

- **Free Shipping**  
orders above ₹
- **Pay with UPI**  
Discount./[Coup](#)
- **Special Bulk**  
Companies an
- **Get Special D**  
WhatsApp@91

### Highlights Brand

- No Brand Nam
- PCB & Projects
- 100% Working
- Tested Project

### Documentation

- Printed Short F
- Printable Soft

### Support

- Demo Video –
- Technical Supp
- [Get Discount C](#)

[Read More](#)

**SKU:** PH\_SPE\_41

**Price:** ₹552.00 Orig  
Current price is: ₹3



**Stock:** instock

**Categories:** [Electronics](#), [General science](#), [Physics](#), [Projects](#), [School Project & Experiment](#)

## Product Description



## Electricity f water

### Package Includ

### Branding Free

- No Brand Name
- PCB & Projects
- Tested Activity

### Documentation

- Free Project Sy
- Printed instruo

### Support

- Working Video
- Technical Supp
- Get Discount C

[Read More](#)

**SKU:** PH\_SPE\_45

**Price:** ₹544.00 Orig  
Current price is: ₹3

**Stock:** instock

**Categories:** [Chem](#)  
[Project & Experime](#)

**Tags:** [class 12th science project and experiment](#), [new science project](#)

## Product Description

## Download Free Project Synopsis

### Disclaimer

This is a handmade complete working Models, Projects & Activity kits supported by rough study material to make a suitable projects report by the student. It is using Cardboard/Wooden base, Paper, Foam based board, stationary items, Electronic-Electrical Components, Mechanical & Scientific goods as per the requirement of a particular model. Colour of product and decoration item may be varying according to availability of material but we make ensure that we will deliver the product with same working, structure and dimensions as describe in product description section.

---



## Electrolysis

### Kit Includes:

- **Project Kit**
- **9V Battery**
- **Print Short R**

### Available offers:

- **Free Shipping**  
orders above P
- **Pay with UPI**  
Discount./[Cou](#)
- **Special Bulk**  
Companies an
- **Get Special D**  
WhatsApp@91

### Highlights Brand

- No Brand Name/Logo/Watermark on Components, PCB & Projects
- 100% Working project
- Tested Project & Activity kits

### Documentation

- Printed Short Report
- Printable Soft copy of Project Report

### Support

- Demo Video – **Embedded below**
- Technical Support – WhatsApp@9109087333
- [Get Discount Coupon](#)

[Read More](#)

**SKU:** PH\_SPE\_42

**Price:**

**Stock:** instock

**Categories:** [Electronics](#), [General science](#), [Physics](#), [Projects](#), [School Project & Experiment](#)

## Product Description

---

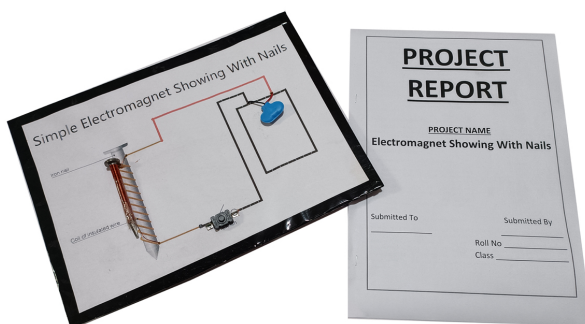

## Electromagnet Showing With Nails

### Kit Includes:

- Project Kit
- 9V Battery
- Print Short Report

### Available offers:

- Free Shipping on orders above ₹1000

- **Pay with UPI QR Code & Get 5% Special Discount.**[/Coupons](#)
- **Special Bulk Discounts** - for colleges, Schools, Companies and resellers. [/Contact Us](#).
- **Get Special Discount Coupon** - WhatsApp@9109087333.

### **Highlights Branding Free Project / Activity kit**

- No Brand Name/Logo/Watermark on Components, PCB & Projects
- 100% Working project
- Tested Project & Activity kits

### **Documentation**

- Printed Short Report
- Printable Soft copy of Project Report

### **Support**

- Demo Video – **Embedded below**
- Technical Support – WhatsApp@9109087333
- [Get Discount Coupon](#)

[Read More](#)

**SKU:** PH\_SPE\_46

**Price:** ~~₹568.00~~ Original price was: ₹568.00. ₹335.00  
Current price is: ₹335.00.

**Stock:** instock

**Categories:** [Electronics](#), [General science](#), [Physics](#), [Projects](#), [School Project & Experiment](#)

## **Product Description**

---



## Electronic E

### Available offer

- **Free Shipping** above Rs999.
- Pay with UPI QR [Coupons](#)
- **Special Bulk D** Companies and
- Get Special Dis 9109087333.

### Highlights

#### Branding Free Pr

- No Brand Name/ Projects
- 100% Working p
- Tested Project &

#### Documentation

- Free Project Syn
- Printed Short Re
- Printable Soft co

#### Support

- Demo Video – **En**
- Technical Suppo
- [Get Discount Co](#)

#### Delivery Time

- **Handling Perio**
- **Transit Time :3**

- **Delivery Time** : Handling Period + Transit Time (4-7 Days Approx.)

[Read More](#)

**SKU:** PH\_EP\_122

**Price:** ~~₹200.00~~ Original price was: ₹200.00. ₹118.00  
Current price is: ₹118.00.

**Stock:** instock

**Categories:** [Engineering project](#), [IC & Transistor](#), [Mini Project](#), [Projects](#)

## Product Description

---

[Download Free Project Synopsis](#)

---

[Working Video:](#)

---

### Disclaimer:

This is a handmade complete working Models, Projects & Activity kits supported by rough study material to make a suitable projects report by the student. It is using Cardboard/Wooden base, Paper, Foam based board, stationary items, Electronic-Electrical Components, Mechanical & Scientific goods as per the requirement of a particular model. Colour of product and decoration item may be varying according to availability of material but we make ensure that we will deliver the product with same working, structure and dimensions as describe in product description section.

---



## Electronic L

### Available offer

- **Free Shipping** above Rs999.
- Pay with UPI QR [Coupons](#)
- **Special Bulk D** Companies and
- Get Special Disc

### Highlights

#### Branding Free Pr

- No Brand Name/ Projects
- 100% Working p
- Tested Project &

#### Documentation

- Free Project Syn
- Printed Short Re
- Printable Soft co

#### Support

- Demo Video – **En**
- Technical Suppo
- [Get Discount Co](#)

[Read More](#)

**SKU:** PH\_EP\_043

**Price:** ₹460.00 Orig  
Current price is: ₹2

**Stock:** instock

**Categories:** [Engineering project](#), [IC & Transistor](#), [Mini Project](#), [Projects](#)

## Product Description

[Download Free Project Synopsis](#)

[Working Video](#)

---

### Disclaimer:

This is a handmade complete working Models, Projects & Activity kits supported by rough study material to make a suitable projects report by the student. It is using Cardboard/Wooden base, Paper, Foam based board, stationary items, Electronic-Electrical Components, Mechanical & Scientific goods as per the requirement of a particular model. Colour of product and decoration item may be varying according to availability of material but we make ensure that we will deliver the product with same working, structure and dimensions as describe in product description section.

---



**Electronic V  
with Separ**

**Package Inc**

**Branding Free**

- No Brand Name
- PCB & Projects
- 100% Working
- Tested Project

**Documentation**



- Free Project Synopsis – ***Embedded below***
- Printed instruction booklet

## Support

- Working Video – ***Embedded Below***
- Technical Support – WhatsApp@9109087333
- Get Discount Coupon – WhatsApp@9303254433

[Read More](#)

**SKU:** PH\_EP\_057

**Price:** ~~₹3,800.00~~ Original price was: ₹3,800.00. ₹  
2,250.00 Current price is: ₹2,250.00.

**Stock:** instock

**Categories:** [Arduino](#), [Engineering project](#), [Exhibition Models & Inspire Award](#), [Projects](#), [Technology & Innovation](#)

**Tags:** [school science project](#), [science exhibition model](#), [security system](#)

## Product Description

## Download Free Project Synopsis

## Working Video

This is a handmade complete working Models, Projects & Activity kits supported by rough study material to make a suitable projects report by the student. It is using Cardboard/Wooden base, Paper, Foam based board, stationary items, Electronic-Electrical Components, Mechanical & Scientific goods as per the requirement of a particular model. Colour of product and decoration item may be varying according to availability of material but we make ensure that we will deliver the product with same working, structure and dimensions as describe in product description section.

---

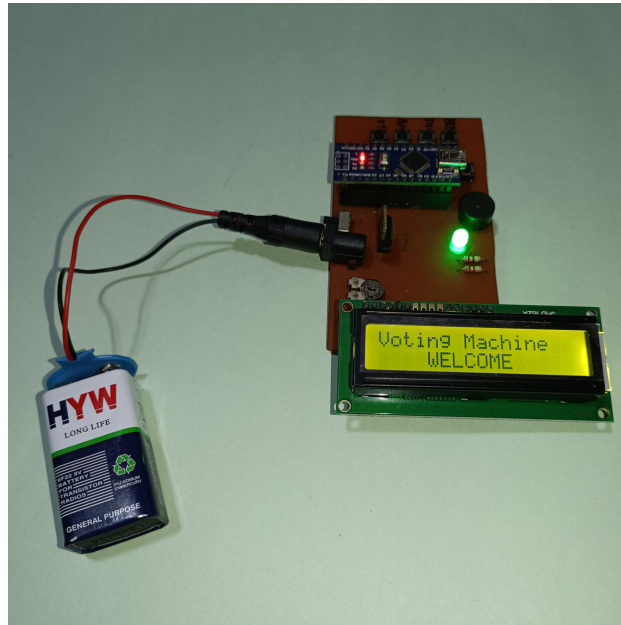

## Electronic Voting Machine Arduino

### Available offers

- **Free Shipping** on orders above Rs999.
- Pay with UPI QR [Coupons](#)
- **Special Bulk Discounts** for Companies and Institutions
- Get Special Discount Code: **9109087333**.

### Highlights

#### Branding Free Project

- No Brand Name/Logo on Projects
- 100% Working project
- Tested Project & Source Code

#### Documentation

- Free Project Synthesis
- Printed Short Report
- Printable Soft copy

#### Support

- Demo Video – [English](#)
- Technical Support
- [Get Discount Code](#)

#### Delivery Time

- **Handling Period**

- **Transit Time** :3-5 Days (Approx.)
- **Delivery Time** : Handling Period + Transit Time (4-7 Days Approx.)

[Read More](#)

**SKU:** PH\_EP\_008

**Price:** ₹2,624.00 Original price was: ₹2,624.00. ₹1,548.00 Current price is: ₹1,548.00.

**Stock:** instock

**Categories:** [Arduino](#), [Engineering project](#), [Projects](#)

## Product Description

## Download Free Project Synopsis

## Working Video

This is a handmade complete working Models, Projects & Activity kits supported by rough study material to make a suitable projects report by the student. It is using Cardboard/Wooden base, Paper, Foam based board, stationary items, Electronic-Electrical Components, Mechanical & Scientific goods as per the requirement of a particular model. Colour of product and decoration item may be varying according to availability of material but we make ensure that we will deliver the product with same working, structure and dimensions as describe in product description section.

---

## Electroplating process

### Kit Includes:

- **Project Kit**
- **9V Battery**
- **Print Short R**

### Available offers:



- **Free Shipping Offer** - Avail free shipping on all orders above Rs999.
- **Pay with UPI QR Code & Get 5% Special Discount.**/[Coupons](#)
- **Special Bulk Discounts** - for colleges, Schools, Companies and resellers. /[Contact Us](#).
- **Get Special Discount Coupon** - WhatsApp@9109087333.

### **Highlights Branding Free Project / Activity kit**

- No Brand Name/Logo/Watermark on Components, PCB & Projects
- 100% Working project
- Tested Project & Activity kits

### **Documentation**

- Printed Short Report
- Printable Soft copy of Project Report

### **Support**

- Demo Video – **Embedded below**
- Technical Support – WhatsApp@9109087333
- [Get Discount Coupon](#)

[Read More](#)

**SKU:** PH\_SPE\_44

**Price:**

**Stock:** instock

**Categories:** [Electronics](#), [General science](#), [Physics](#), [Projects](#), [School Project & Experiment](#)

## **Product Description**

---

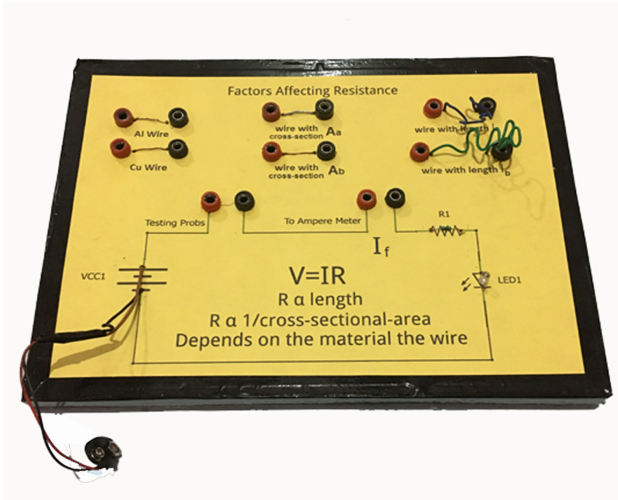

## Factors Affecting Resistance ( Cu and Al Wire)

### Package Includes:

### Branding Free Activity kit

- No Brand Name/Logo/Watermark on Components, PCB & Projects
- Tested Activity kits

### Documentation

- Free Project Synopsis – **Embedded below**
- Printed instruction booklet

### Support

- Working Video – **Embedded Below**
- Technical Support – WhatsApp@9109087333
- Get Discount Coupon - WhatsApp@9303254433

[Read More](#)

**SKU:** PH\_SPE\_49

**Price:** ₹560.00 Original price was: ₹560.00.₹330.00  
Current price is: ₹330.00.

**Stock:** instock

**Categories:** [Electricity & Magnetism](#), [Electronics](#), [Physics](#), [Projects](#), [School Project & Experiment](#)

**Tags:** [class 12th science project and experiment](#), [new science project](#)

## Product Description

## Download Free Project Synopsis

## Disclaimer

This is a handmade complete working Models, Projects & Activity kits supported by rough study material to make a suitable projects report by the student. It is using Cardboard/Wooden base, Paper, Foam based board, stationary items, Electronic-Electrical Components, Mechanical & Scientific goods as per the requirement of a particular model. Colour of product and decoration item may be varying according to availability of material but we make ensure that we will deliver the product with same working, structure and dimensions as describe in product description section.

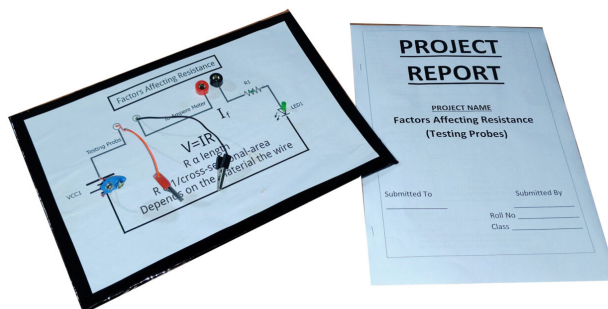

## Factors Affecting Resistance (testing probes)

### Package Includes

### Branding Free

- No Brand Name
- PCB & Projects
- Tested Activity

### Documentation

- Free Project Syllabus
- Printed instructions

### Support

- Working Video
- Technical Support
- Get Discount Code

[Read More](#)

**SKU:** PH\_SPE\_50

**Price:** ₹436.00 Original Price  
Current price is: ₹218.00

**Stock:** instock

**Categories:** [Electricity & Magnetism](#), [Electronics](#), [Physics](#), [Projects](#), [School Project & Experiment](#)

**Tags:** [class 12th science project and experiment](#), [new science project](#)

## Product Description

## Download Free Project Synopsis

### Disclaimer

This is a handmade complete working Models, Projects & Activity kits supported by rough study material to make a suitable projects report by the student. It is using Cardboard/Wooden base, Paper, Foam based board, stationary items, Electronic-Electrical Components, Mechanical & Scientific goods as per the requirement of a particular model. Colour of product and decoration item may be varying according to availability of material but we make ensure that we will deliver the product with same working, structure and dimensions as describe in product description section.

---

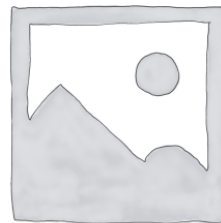

## Faraday's Law of Electromagnetic Induction

### Kit Includes:

- **Project Kit**
- **9V Battery**
- **Print Short Report**

### Available offers:

- **Free Shipping** on orders above ₹ 500
- **Pay with UPI** Get 5% Discount./[Coupon](#)
- **Special Bulk** Discounts for Companies and Institutions

- **Get Special Discount Coupon –**  
WhatsApp@9109087333.

### **Highlights Branding Free Project / Activity kit**

- No Brand Name/Logo/Watermark on Components, PCB & Projects
- 100% Working project
- Tested Project & Activity kits

### **Documentation**

- Printed Short Report
- Printable Soft copy of Project Report

### **Support**

- Demo Video – **Embedded below**
- Technical Support – WhatsApp@9109087333
- [Get Discount Coupon](#)

[Read More](#)

**SKU:** PH\_SPE\_52

**Price:** ~~₹584.00~~ Original price was: ₹584.00. ₹345.00  
Current price is: ₹345.00.

**Stock:** instock

**Categories:** [Electronics](#), [General science](#), [Physics](#), [Projects](#), [School Project & Experiment](#)

## **Product Description**

---





## Faraday's L Electromag Variables th

### Kit Includes:

- **Project Kit**
- **9V Battery**
- **Print Short R**

### Available offers:

- **Free Shipping**  
orders above ₹
- **Pay with UPI**  
Discount./[Cou](#)
- **Special Bulk**  
Companies an
- **Get Special D**  
WhatsApp@91

### Highlights Brand

- No Brand Nam  
PCB & Projects
- 100% Working
- Tested Project

### Documentation

- Printed Short P
- Printable Soft c

### Support

- Demo Video –
- Technical Supp
- [Get Discount C](#)

[Read More](#)

**SKU:** PH\_SPE\_51

**Price:**

**Stock:** instock

**Categories:** [Electronics](#), [General science](#), [Physics](#), [Projects](#), [School Project & Experiment](#)

## Product Description

---



## Fence Wire using Trans

### Available offer

- **Free Shipping** above Rs999.
- Pay with UPI QR [Coupons](#)
- **Special Bulk D** Companies and
- Get Special Dis 9109087333.

### Highlights

#### Branding Free Pr

- No Brand Name/ Projects
- 100% Working p
- Tested Project &

#### Documentation

- Free Project Syn
- Printed Short Re

- Printable Soft copy of Project Report

### Support

- Demo Video – **Embedded below**
- Technical Support – WhatsApp@9109087333
- [Get Discount Coupon](#)

### Delivery Time

- **Handling Period** : 1-2 Days
- **Transit Time** :3-5 Days (Approx.)
- **Delivery Time** : Handling Period + Transit Time (4-7 Days Approx.)

[Read More](#)

**SKU:** PH\_EP\_132

**Price:** ₹240.00 Original price was: ₹240.00. ₹142.00  
Current price is: ₹142.00.

**Stock:** instock

**Categories:** [Engineering project](#), [IC & Transistor](#), [Mini Project](#), [Projects](#)

## Product Description

---

**Download Free Project Synopsis**

---

**Working Video:**

---

### Disclaimer:

This is a handmade complete working Models, Projects & Activity kits supported by rough study material to make a suitable projects report by the student. It is using Cardboard/Wooden base, Paper, Foam based board, stationary items, Electronic-Electrical Components, Mechanical & Scientific goods as per the requirement of a particular model. Colour of product and decoration item may be varying according to availability of material but we make ensure that we will deliver the product with same working, structure and dimensions as describe in product

description section.

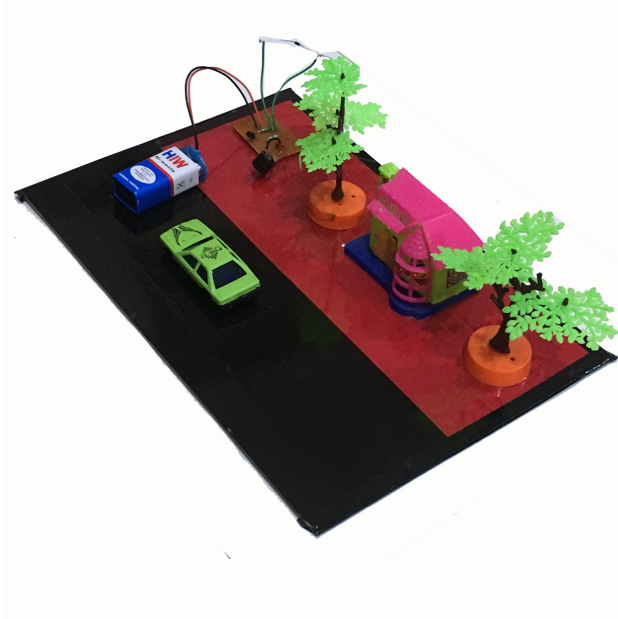

## Fire Alarm Exhibition Model

### Package Includes:

#### Branding Free Project / Activity kit

- No Brand Name/Logo/Watermark on Components, PCB & Projects
- 100% Working project
- Tested Project & Activity kits

#### Documentation

- Free Project Synopsis – ***Embedded below***
- Printed instruction booklet

#### Support

- Working Video – ***Embedded Below***
- Technical Support – WhatsApp@9109087333
- Get Discount Coupon – WhatsApp@9303254433

[Read More](#)

**SKU:** PH\_SEM\_04

**Price:** ~~₹732.00~~ Original price was: ₹732.00. ₹432.00  
Current price is: ₹432.00.

**Stock:** instock

**Categories:** [Exhibition Models & Inspire Award](#),  
[Security](#), [Technology & Innovation](#)

**Tags:** [school science project](#), [science exhibition model](#),  
[security system](#)

## Product Description

## Download Free Project Synopsis

This is a handmade complete working Models, Projects & Activity kits supported by rough study material to make a suitable projects report by the student. It is using Cardboard/Wooden base, Paper, Foam based board, stationary items, Electronic-Electrical Components, Mechanical & Scientific goods as per the requirement of a particular model. Colour of product and decoration item may be varying according to availability of material but we make ensure that we will deliver the product with same working, structure and dimensions as describe in product description section.

---

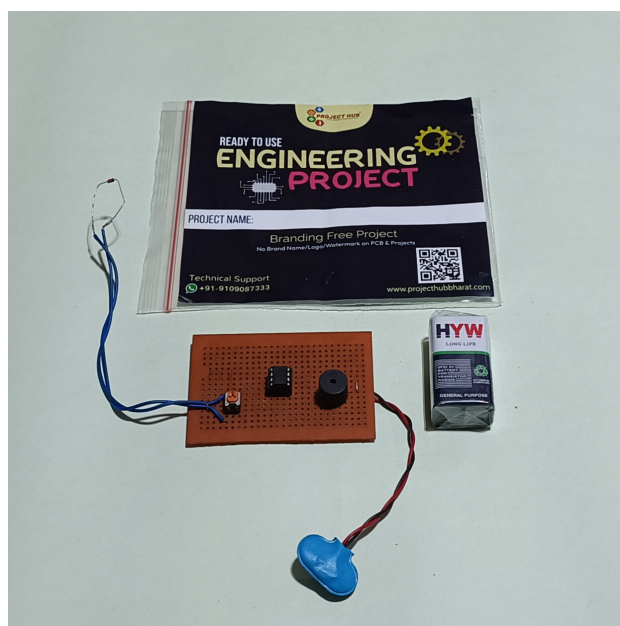

## Fire Alarm

### Package Includes

### Branding Free

- No Brand Name
- PCB & Projects
- 100% Working
- Tested Project

### Documentation

- Free Project Sy
- Printed instruct
- Printable Soft
- PPT

### Support

- Demo Video –
- Technical Supp
- Get Discount C

[Read More](#)

**SKU:** PH\_EP\_091

**Price:** ₹360.00 Orig  
Current price is: ₹2

**Stock:** instock

**Categories:** [Engineering project](#), [IC & Transistor](#), [Mini Project](#), [Projects](#), [Security](#)

## Product Description

## Download Free Project Synopsis

### Working Video

This is a handmade complete working Models, Projects & Activity kits supported by rough study material to make a suitable projects report by the student. It is using Cardboard/Wooden base, Paper, Foam based board, stationary items, Electronic-Electrical Components, Mechanical & Scientific goods as per the requirement of a particular model. Colour of product and decoration item may be varying according to availability of material but we make ensure that we will deliver the product with same working, structure and dimensions as describe in product description section.

---



## Fire Alarm PCB

### Available offer

- **Free Shipping** above Rs999.
- COD available in above 999.
- Pay with UPI QR [Coupons](#)
- **Special Bulk D** Companies and
- Get Special Disc

## Highlights

### Branding Free Pr

- No Brand Name/Logo/Watermark on Components, PCB & Projects
- 100% Working project
- Tested Project & Activity kits

### Documentation

- Free Project Synopsis - **Embedded below**
- Printed Short Report
- Printable Soft copy of Project Report

### Support

- Demo Video - **Embedded below**
- Technical Support - WhatsApp@9109087333
- [Get Discount Coupon](#)

Click Here to Buy Do It Yourself Kit

[Read More](#)

**SKU:** PH\_EP\_022

**Price:** ~~₹384.00~~ Original price was: ₹384.00. ₹227.00  
Current price is: ₹227.00.

**Stock:** instock

**Categories:** [Engineering project](#), [IC & Transistor](#), [Mini Project](#), [Projects](#)

## Product Description

### INTRODUCTION:

The fire alarm project is a safety device designed to detect and alert individuals in the event of a fire outbreak. This project utilizes the IC 555 timer, a widely used integrated circuit, in conjunction with a buzzer, 9V battery, and a 1N4148 Zener diode acting as a heat sensor. The system works by monitoring changes in temperature and triggering an alarm when the temperature exceeds a predefined threshold, indicating the presence of fire or excessive heat.

### ADVANTAGES:

- Cost-effective solution for fire detection.

- Simple circuit design using easily available components.
- Portable and battery-powered, allowing it to be used in various settings.
- Provides an immediate audible alert to warn occupants of potential danger.
- Can be integrated into larger fire safety systems.

### **APPLICATIONS:**

- Residential buildings: Houses, apartments, and dormitories.
- Offices and commercial spaces.
- Industrial facilities and warehouses.
- Educational institutions: Schools, colleges, and universities.
- Public places: Theatre's, shopping malls, and airports.
- Any location where early fire detection is crucial for safety.

---

### **[Download Free Project Synopsis](#)**

### **Working Video**

---

### **Disclaimer:**

This is a handmade complete working Models, Projects & Activity kits supported by rough study material to make a suitable projects report by the student. It is using Cardboard/Wooden base, Paper, Foam based board, stationary items, Electronic-Electrical Components, Mechanical & Scientific goods as per the requirement of a particular model. Colour of product and decoration item may be varying according to availability of material but we make ensure that we will deliver the product with same working, structure and dimensions as describe in product description section.

---



# Fire Alarm Using IC555



## Package Includes:

## Branding Free Activity kit

- No Brand Name/Logo/Watermark on Components, PCB & Projects
- Tested Activity kits

## Documentation

- Free Project Synopsis – **Embedded below**
- Printed instruction booklet

## Support

- Working Video – **Embedded Below**
- Technical Support – WhatsApp@9109087333
- Get Discount Coupon - WhatsApp@9303254433

[Read More](#)

**SKU:** PH\_SPE\_54

**Price:** ~~₹468.00~~ Original price was: ₹468.00. ₹276.00  
Current price is: ₹276.00.

**Stock:** instock

**Categories:** [Electronics](#), [Projects](#), [School Project & Experiment](#)

**Tags:** [class 12th science project and experiment](#), [new science project](#)

## Product Description

## Download Free Project Synopsis

## Disclaimer

This is a handmade complete working Models, Projects & Activity kits supported by rough study material to make a suitable projects report by the student. It is using Cardboard/Wooden base, Paper, Foam based board, stationary items, Electronic-Electrical Components, Mechanical & Scientific goods as per the requirement of a particular model. Colour of product and decoration item may be varying according to availability of material but we make ensure that we will deliver the product with same working, structure and dimensions as describe in product description section.

---

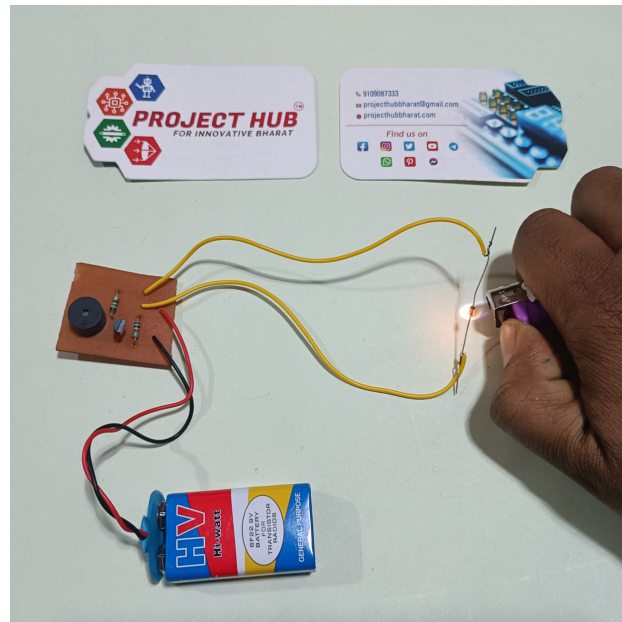

## Fire Alarm u Diode

### Available offer

- **Free Shipping** above Rs999.
- Pay with UPI QR [Coupons](#)
- **Special Bulk D** Companies and
- Get Special Dis 9109087333.

### Highlights

#### Branding Free Pr

- No Brand Name/ Projects
- 100% Working p
- Tested Project &

#### Documentation

- Free Project Syn
- Printed Short Re
- Printable Soft co

## Support

- Demo Video – **Embedded below**
- Technical Support – WhatsApp@9109087333
- [Get Discount Coupon](#)

## Delivery Time

- **Handling Period** : 1-2 Days
- **Transit Time** :3-5 Days (Approx.)
- **Delivery Time** : Handling Period + Transit Time (4-7 Days Approx.)

[Read More](#)

**SKU:** PH\_EP\_134

**Price:**

**Stock:** instock

**Categories:** [Engineering project](#), [IC & Transistor](#), [Mini Project](#), [Projects](#)

## Product Description

---

**Download Free Project Synopsis**

---

**Working Video:**

---

### **Disclaimer:**

This is a handmade complete working Models, Projects & Activity kits supported by rough study material to make a suitable projects report by the student. It is using Cardboard/Wooden base, Paper, Foam based board, stationary items, Electronic-Electrical Components, Mechanical & Scientific goods as per the requirement of a particular model. Colour of product and decoration item may be varying according to availability of material but we make ensure that we will deliver the product with same working, structure and dimensions as describe in product description section.

---

## Fire Alarm Using Transistors

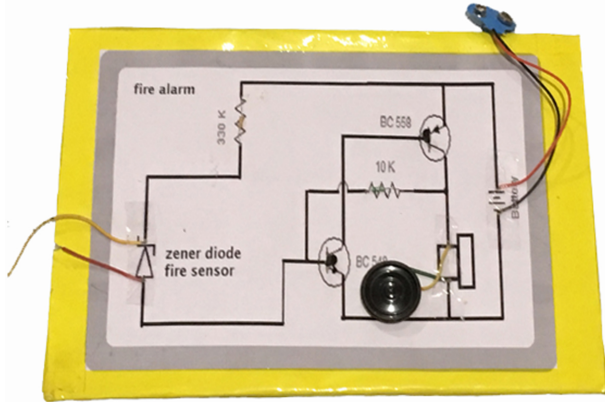

### Package Includes:

### Branding Free Activity kit

- No Brand Name/Logo/Watermark on Components, PCB & Projects
- Tested Activity kits

### Documentation

- Free Project Synopsis – **Embedded below**
- Printed instruction booklet

### Support

- Working Video – **Embedded Below**
- Technical Support – WhatsApp@9109087333
- Get Discount Coupon - WhatsApp@9303254433

[Read More](#)

**SKU:** PH\_SPE\_55

**Price:** ~~₹392.00~~ Original price was: ₹392.00. ₹231.00  
Current price is: ₹231.00.

**Stock:** instock

**Categories:** [Electronics](#), [Projects](#), [School Project & Experiment](#)

**Tags:** [class 12th science project and experiment](#), [new science project](#)

### Product Description

## Download Free Project Synopsis

## Disclaimer

This is a handmade complete working Models, Projects & Activity kits supported by rough study material to make a suitable projects report by the student. It is using Cardboard/Wooden base, Paper, Foam based board, stationary items, Electronic-Electrical Components, Mechanical & Scientific goods as per the requirement of a particular model. Colour of product and decoration item may be varying according to availability of material but we make ensure that we will deliver the product with same working, structure and dimensions as describe in product description section.

---